

# **PHILIPPINE BIDDING DOCUMENTS**



## **CONSTRUCTION OF ONE (1)-UNIT COVERED COURT IN SITIO SAYUGAN INTERIOR, BRGY. MALIGAYA, LAMITAN CITY, BASILAN**

Government of the Republic of the  
Philippines

**Sixth Edition  
July 2020**

## TABLE OF CONTENTS

<b>Glossary of Terms, Abbreviations, and Acronyms</b> defined.	<b>Error! Bookmark not</b>
<b>Section I. Invitation to Bid</b>	<b>3</b>
<b>Section II. Instructions to Bidders</b>	<b>8</b>
<b>Section III. Bid Data Sheet</b>	<b>15</b>
<b>Section IV. General Conditions of Contract</b>	<b>19</b>
<b>Section V. Special Conditions of Contract</b>	<b>24</b>
<b>Section VI. Specifications</b>	<b>26</b>
<b>Section VII. Drawings</b>	<b>125</b>
<b>Section VIII. Bill of Quantities</b>	<b>126</b>
<b>Section IX. Checklist of Technical and Financial Documents</b>	<b>128</b>

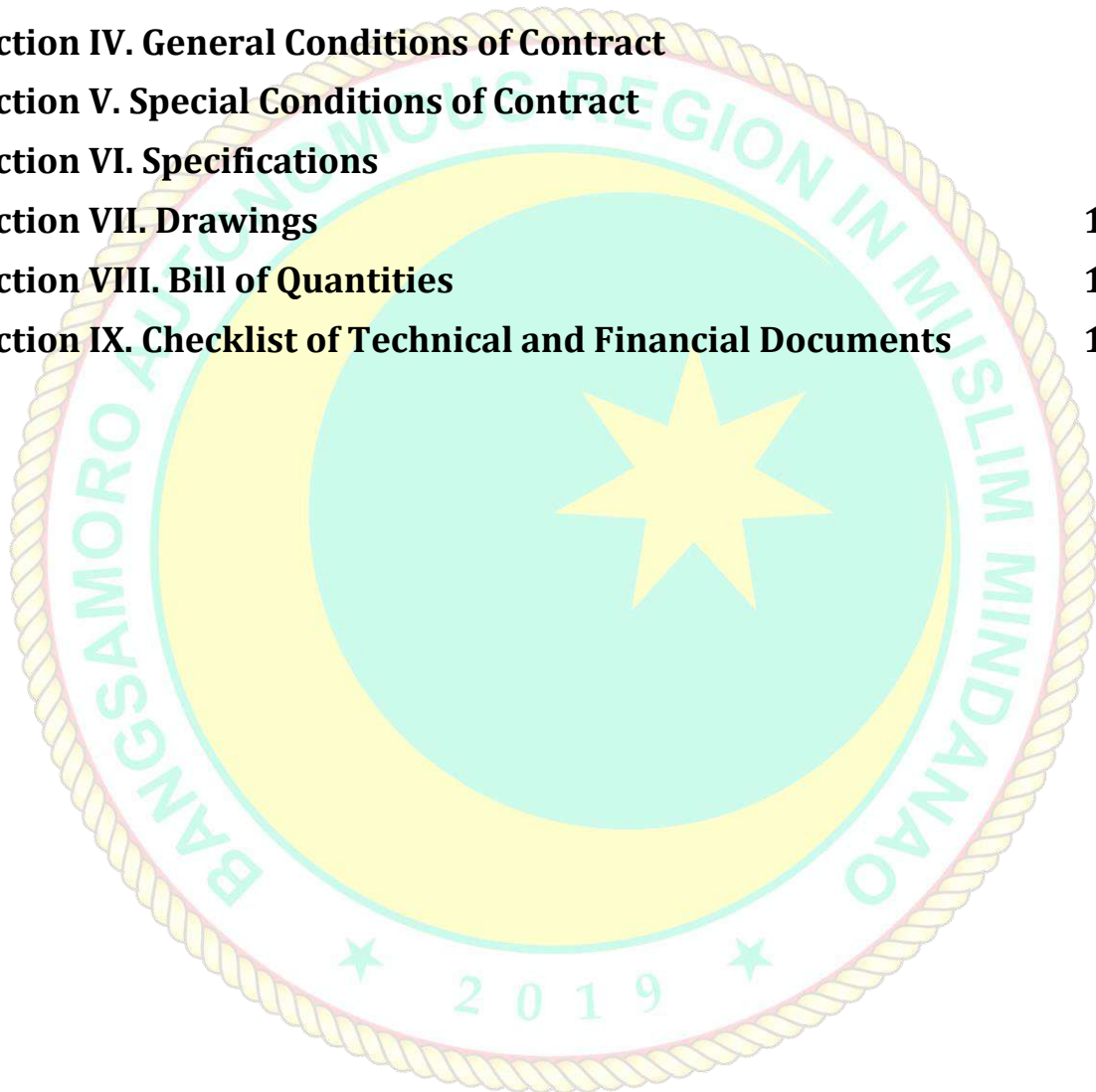



## **Section I. Invitation to Bid**



Republic of the Philippines  
**BANGSAMORO AUTONOMOUS REGION IN MUSLIM MINDANAO**  
**OFFICE OF THE CHIEF MINISTER**  
**BIDS AND AWARDS COMMITTEE**  
**SPECIAL DEVELOPMENT FUND**

Bangsamoro Government Center, Governor Gutierrez Avenue, Rosary Heights VII, Cotabato City 9600

**Invitation to Bid for the**  
**CONSTRUCTION OF ONE (1)-UNIT COVERED COURT IN**  
**SITIO SAYUGAN INTERIOR, BRGY. MALIGAYA,**  
**LAMITAN CITY, BASILAN**

IB No.: SDF-102023-08

1. The **Office of the Chief Minister, Bangsamoro Autonomous Region in Muslim Mindanao (OCM-BARMM)**, through the **Special Development Fund of 2020** intends to apply the sum of **Three Million Pesos (PHP 3,000,000.00)** being the Approved Budget for the Contract (ABC) to payments under the contract for the **Construction of One (1)-Unit Covered Court in Sitio Sayugan Interior, Brgy. Maligaya, Lamitan City, Basilan.**

Bids received in excess of the ABC for each lot shall be automatically rejected at bid opening.

2. The **OCM-BARMM** now invites bids for the above Procurement Project. Completion of the Works is required **90 Calendar Days**. Bidders should have completed a contract similar to the Project. The description of an eligible bidder is contained in the Bidding Documents, particularly, in Section II (Instructions to Bidders).
3. Bidding will be conducted through open competitive bidding procedures using non-discretionary "pass/fail" criterion as specified in the 2016 revised Implementing Rules and Regulations (IRR) of Republic Act (RA) No. 9184.
4. Interested bidders may obtain further information from **OCM-BARMM** and inspect the Bidding Documents at the address given below from **8:00 AM – 5:00 PM**.
5. A complete set of Bidding Documents may be acquired by interested Bidders on **October 27-November 20, 2023, during office hours**, from the given address and website(s) below upon payment of the applicable fee for the Bidding Documents, in the amount of **Five Thousand Pesos (PHP 5,000.00)**, pursuant to the latest Guidelines issued by the GPPB. The Procuring Entity shall allow the bidder to present its proof of payment for the fees in person.



The bidder or its duly authorized representative shall present the following documents when purchasing the bidding documents, to wit:

- a. Letter of Intent;
- b. Proof of Authority. i.e., Special Power of Attorney or Secretary's Certificate; and
- c. Valid Government issued I.D of the owner or its duly authorized representative.

6. The OCM-BARMM will hold a **Pre-Bid Conference<sup>1</sup>** on **November 7, 2023, 9:00 a.m.** via **Zoom Teleconference** which shall be open to prospective bidders. The zoom details may be requested at [ocmbac@bangsamoro.gov.ph](mailto:ocmbac@bangsamoro.gov.ph).

7. Bids must be duly received by the BAC Secretariat through manual submission at **Ground floor, Bangsamoro Development and Authority (BPDA) Conference Hall 2, BPDA, Bangsamoro Government Center, Cotabato City, on or before November 21, 2023, 8:30 a.m.** Late bids shall not be accepted.

All Bids must be accompanied by a bid security in any of the acceptable forms and in the amount stated in **ITB** Clause 14.

8. Bid opening shall be on **November 21, 2023, 9:00 a.m. at Ground floor, Bangsamoro Development and Authority (BPDA) Conference Hall 2, BPDA, Bangsamoro Government Center, Cotabato City.** Bids will be opened in the presence of the bidders' representatives who choose to attend the activity.

9. The **OCM-BARMM** reserves the right to reject any and all bids, declare a failure of bidding, or not award the contract at any time prior to contract award in accordance with Sections 35.6 and 41 of the 2016 revised Implementing Rules and Regulations (IRR) of RA No. 9184, without thereby incurring any liability to the affected bidder or bidders.

10. **For further information, please refer to:**

<ol style="list-style-type: none"><li>a. Sale of Bidding</li><li>b. Query on How to submit bids</li><li>c. Links for online connectivity for procurement activities</li><li>d. Written Clarifications on the project</li></ol>	<p><b>Bids and Awards Committee Secretariat</b></p> <p><a href="mailto:ocmbac@bangsamoro.gov.ph">ocmbac@bangsamoro.gov.ph</a></p> <p>0917-831-7214</p>
--	--

---

<sup>1</sup> May be deleted in case the ABC is less than One Million Pesos (PhP1,000,000) where the Procuring Entity may not hold a Pre-Bid Conference.

Plans, Drawings, and Bill of Quantities	<b>Special Development Fund-PMO</b> (064) 557-2797 sdf@bangsamoro.gov.ph
---	--

11. You may visit the following websites:

For downloading of Bidding Documents:

<https://bangsamoro.gov.ph/transparency/bids-and-awards-committee/#ITB>

*Originally signed*

**MOHD ASNIN K. PENDATUN**

Chairperson, Special Bids and Awards Committee



## Section II. Instructions to Bidders

### 1. Scope of Bid

The Procuring Entity, **OCM-BARMM** invites Bids for the **Construction of One (1)-Unit Covered Court in Sitio Sayugan Interior, Brgy. Maligaya, Lamitan City, Basilan**, with Project Identification Number SDF-102023-08.

The Procurement Project (referred to herein as “Project”) is for the construction of Works, as described in Section VI (Specifications).

### 2. Funding Information

2.1. The GOP through the source of funding as indicated below for **SPECIAL DEVELOPMENT FUND OF 2020** in the amount of **PHP 3,000,000.00**.

2.2. The source of funding is: **NGA, the General Appropriations Act or Special Appropriations.**

### 3. Bidding Requirements

The Bidding for the Project shall be governed by all the provisions of RA No. 9184 and its 2016 revised IRR, including its Generic Procurement Manual and associated policies, rules and regulations as the primary source thereof, while the herein clauses shall serve as the secondary source thereof.

Any amendments made to the IRR and other GPPB issuances shall be applicable only to the ongoing posting, advertisement, or invitation to bid by the BAC through the issuance of a supplemental or bid bulletin.

The Bidder, by the act of submitting its Bid, shall be deemed to have inspected the site, determined the general characteristics of the contracted Works and the conditions for this Project, such as the location and the nature of the work; (b) climatic conditions; (c) transportation facilities; (c) nature and condition of the terrain, geological conditions at the site communication facilities, requirements, location and availability of construction aggregates and other materials, labor, water, electric power and access roads; and (d) other factors that may affect the cost, duration and execution or implementation of the contract, project, or work and examine all instructions, forms, terms, and project requirements in the Bidding Documents.

### 4. Corrupt, Fraudulent, Collusive, Coercive, and Obstructive Practices

The Procuring Entity, as well as the Bidders and Contractors, shall observe the highest standard of ethics during the procurement and execution of the contract. They or through an agent shall not engage in corrupt, fraudulent, collusive,

coercive, and obstructive practices defined under Annex “I” of the 2016 revised IRR of RA No. 9184 or other integrity violations in competing for the Project.

## 5. Eligible Bidders

- 5.1. Only Bids of Bidders found to be legally, technically, and financially capable will be evaluated.
- 5.2. The Bidder must have an experience of having completed a Single Largest Completed Contract (SLCC) that is similar to this Project, equivalent to at least fifty percent (50%) of the ABC adjusted, if necessary, by the Bidder to current prices using the PSA’s CPI, except under conditions provided for in Section 23.4.2.4 of the 2016 revised IRR of RA No. 9184.

A contract is considered to be “similar” to the contract to be bid if it has the major categories of work stated in the **BDS**.

- 5.3. For Foreign-funded Procurement, the Procuring Entity and the foreign government/foreign or international financing institution may agree on another track record requirement, as specified in the Bidding Document prepared for this purpose.
- 5.4. The Bidders shall comply with the eligibility criteria under Section 23.4.2 of the 2016 IRR of RA No. 9184.

## 6. Origin of Associated Goods

There is no restriction on the origin of Goods other than those prohibited by a decision of the UN Security Council taken under Chapter VII of the Charter of the UN.

## 7. Subcontracts

- 7.1. The Bidder may subcontract portions of the Project to the extent allowed by the Procuring Entity as stated herein, but in no case more than fifty percent (50%) of the Project.

The Procuring Entity has prescribed that: **Subcontracting is not allowed.**

## 8. Pre-Bid Conference

The Procuring Entity will hold a pre-bid conference for this Project on the specified date and time and either at its physical address **Bajau Hall, 2F Office of the Chief Minister-BARMM, Bangsamoro Government Center, Gov. Gutierrez Avenue, Cotabato City** and/or through videoconferencing/webcasting} as indicated in paragraph 6 of the **IB**.



## 9. Clarification and Amendment of Bidding Documents

Prospective bidders may request for clarification on and/or interpretation of any part of the Bidding Documents. Such requests must be in writing and received by the Procuring Entity, either at its given address or through electronic mail indicated in the **IB**, at least ten (10) calendar days before the deadline set for the submission and receipt of Bids.

## 10. Documents Comprising the Bid: Eligibility and Technical Components

- 10.1. The first envelope shall contain the eligibility and technical documents of the Bid as specified in **Section IX. Checklist of Technical and Financial Documents**.
- 10.2. If the eligibility requirements or statements, the bids, and all other documents for submission to the BAC are in foreign language other than English, it must be accompanied by a translation in English, which shall be authenticated by the appropriate Philippine foreign service establishment, post, or the equivalent office having jurisdiction over the foreign bidder's affairs in the Philippines. For Contracting Parties to the Apostille Convention, only the translated documents shall be authenticated through an apostille pursuant to GPPB Resolution No. 13-2019 dated 23 May 2019. The English translation shall govern, for purposes of interpretation of the bid.
- 10.3. A valid PCAB License is required, and in case of joint ventures, a valid special PCAB License, and registration for the type and cost of the contract for this Project. Any additional type of Contractor license or permit shall be indicated in the **BDS**.
- 10.4. A List of Contractor's key personnel (e.g., Project Manager, Project Engineers, Materials Engineers, and Foremen) assigned to the contract to be bid, with their complete qualification and experience data shall be provided. These key personnel must meet the required minimum years of experience set in the **BDS**.
- 10.5. A List of Contractor's major equipment units, which are owned, leased, and/or under purchase agreements, supported by proof of ownership, certification of availability of equipment from the equipment lessor/vendor for the duration of the project, as the case may be, must meet the minimum requirements for the contract set in the **BDS**.

## 11. Documents Comprising the Bid: Financial Component

- 11.1. The second bid envelope shall contain the financial documents for the Bid as specified in **Section IX. Checklist of Technical and Financial Documents**.

- 11.2. Any bid exceeding the ABC indicated in paragraph 1 of the **IB** shall not be accepted.
- 11.3. For Foreign-funded procurement, a ceiling may be applied to bid prices provided the conditions are met under Section 31.2 of the 2016 revised IRR of RA No. 9184.

## **12. Alternative Bids**

Bidders shall submit offers that comply with the requirements of the Bidding Documents, including the basic technical design as indicated in the drawings and specifications. Unless there is a value engineering clause in the **BDS**, alternative Bids shall not be accepted.

## **13. Bid Prices**

All bid prices for the given scope of work in the Project as awarded shall be considered as fixed prices, and therefore not subject to price escalation during contract implementation, except under extraordinary circumstances as determined by the NEDA and approved by the GPPB pursuant to the revised Guidelines for Contract Price Escalation guidelines.

## **14. Bid and Payment Currencies**

- 14.1. Bid prices may be quoted in the local currency or tradeable currency accepted by the BSP at the discretion of the Bidder. However, for purposes of bid evaluation, Bids denominated in foreign currencies shall be converted to Philippine currency based on the exchange rate as published in the BSP reference rate bulletin on the day of the bid opening.
- 14.2. Payment of the contract price shall be made in: Philippine Pesos.

## **15. Bid Security**

- 15.1. The Bidder shall submit a Bid Securing Declaration or any form of Bid Security in the amount indicated in the **BDS**, which shall be not less than the percentage of the ABC in accordance with the schedule in the **BDS**.
- 15.2. The Bid and bid security shall be valid until **120 CALENDAR DAYS FROM THE BID SUBMISSION**. Any bid not accompanied by an acceptable bid security shall be rejected by the Procuring Entity as non-responsive.

## **16. Sealing and Marking of Bids**

Each Bidder shall submit one copy of the first and second components of its Bid.

The Procuring Entity may request additional hard copies and/or electronic copies of the Bid. However, failure of the Bidders to comply with the said request shall not be a ground for disqualification.

If the Procuring Entity allows the submission of bids through online submission to the given website or any other electronic means, the Bidder shall submit an electronic copy of its Bid, which must be digitally signed. An electronic copy that cannot be opened or is corrupted shall be considered non-responsive and, thus, automatically disqualified.

## **17. Deadline for Submission of Bids**

The Bidders shall submit on the specified date and time and either at its physical address or through online submission as indicated in paragraph 7 of the **IB**.

## **18. Opening and Preliminary Examination of Bids**

18.1. The BAC shall open the Bids in public at the time, on the date, and at the place specified in paragraph 9 of the **IB**. The Bidders' representatives who are present shall sign a register evidencing their attendance. In case videoconferencing, webcasting or other similar technologies will be used, attendance of participants shall likewise be recorded by the BAC Secretariat.

In case the Bids cannot be opened as scheduled due to justifiable reasons, the rescheduling requirements under Section 29 of the 2016 revised IRR of RA No. 9184 shall prevail.

18.2. The preliminary examination of Bids shall be governed by Section 30 of the 2016 revised IRR of RA No. 9184.

## **19. Detailed Evaluation and Comparison of Bids**

19.1. The Procuring Entity's BAC shall immediately conduct a detailed evaluation of all Bids rated "passed" using non-discretionary pass/fail criteria. The BAC shall consider the conditions in the evaluation of Bids under Section 32.2 of 2016 revised IRR of RA No. 9184.

19.2. If the Project allows partial bids, all Bids and combinations of Bids as indicated in the **BDS** shall be received by the same deadline and opened and evaluated simultaneously so as to determine the Bid or combination of Bids offering the lowest calculated cost to the Procuring Entity. Bid Security as required by **ITB** Clause 16 shall be submitted for each contract (lot) separately.

19.3. In all cases, the NFCC computation pursuant to Section 23.4.2.6 of the 2016 revised IRR of RA No. 9184 must be sufficient for the total of the ABCs for all the lots participated in by the prospective Bidder.

## 20. Post Qualification

Within a non-extendible period of five (5) calendar days from receipt by the Bidder of the notice from the BAC that it submitted the Lowest Calculated Bid, the Bidder shall submit its latest income and business tax returns filed and paid through the BIR Electronic Filing and Payment System (eFPS), and other appropriate licenses and permits required by law and stated in the **BDS**.

## 21. Signing of the Contract

The documents required in Section 37.2 of the 2016 revised IRR of RA No. 9184 shall form part of the Contract. Additional Contract documents are indicated in the **BDS**.







## **Section III. Bid Data Sheet**

# Bid Data Sheet

ITB Clause																					
5.2	<p>For this purpose, contracts similar to the Project refer to contracts which have the same major categories of work, which shall be:</p> <ul style="list-style-type: none"> <li>a. Construction of Building or any other contracts analogous thereto; and</li> <li>b. at least equivalent to the 50% of the ABC.</li> </ul> <p>However, contractors under Small A and Small B categories without similar experience on the contract to be bid may be allowed to bid if the cost of such contract is not more than the Allowable Range of Contract Cost (ARCC) of their registration based on the guidelines as prescribed by the PCAB.</p>																				
7.1	Not applicable.																				
10.3	<p>PCAB License Requirement is:</p> <p>Size Range : Small B License Category: C&amp;D</p>																				
10.4	<p>The key personnel must meet the required minimum years of experience set below:</p> <table border="1" style="width: 100%; border-collapse: collapse; margin-top: 10px;"> <thead> <tr> <th style="text-align: center;">Key Personnel</th> <th style="text-align: center;">General Experience</th> <th style="text-align: center;">Minimum Relevant Experience</th> </tr> </thead> <tbody> <tr> <td style="text-align: center;">1 Project Engineer</td> <td style="text-align: center;">Construction</td> <td style="text-align: center;">5 years</td> </tr> <tr> <td style="text-align: center;">1 Safety Officer</td> <td style="text-align: center;">Construction Occupational Safety and Health</td> <td style="text-align: center;">3 years</td> </tr> <tr> <td style="text-align: center;">1 Materials Engineer</td> <td style="text-align: center;">Material Testing</td> <td style="text-align: center;">3 years</td> </tr> <tr> <td style="text-align: center;">1 Construction Foreman</td> <td style="text-align: center;">Supervision</td> <td style="text-align: center;">5 years</td> </tr> <tr> <td style="text-align: center;">1 Health Personnel</td> <td style="text-align: center;">Health in Construction</td> <td style="text-align: center;">2 years</td> </tr> </tbody> </table>			Key Personnel	General Experience	Minimum Relevant Experience	1 Project Engineer	Construction	5 years	1 Safety Officer	Construction Occupational Safety and Health	3 years	1 Materials Engineer	Material Testing	3 years	1 Construction Foreman	Supervision	5 years	1 Health Personnel	Health in Construction	2 years
Key Personnel	General Experience	Minimum Relevant Experience																			
1 Project Engineer	Construction	5 years																			
1 Safety Officer	Construction Occupational Safety and Health	3 years																			
1 Materials Engineer	Material Testing	3 years																			
1 Construction Foreman	Supervision	5 years																			
1 Health Personnel	Health in Construction	2 years																			

10.5	<p>The minimum major equipment requirements are the following:</p> <table border="1" data-bbox="384 219 1378 573"> <thead> <tr> <th data-bbox="384 219 727 286">Equipment</th> <th data-bbox="727 219 1050 286">Minimum Specifications</th> <th data-bbox="1050 219 1378 286">Minimum Number of Units</th> </tr> </thead> <tbody> <tr> <td data-bbox="384 286 727 322">Bar Cutter</td> <td data-bbox="727 286 1050 322">20-mm. capacity</td> <td data-bbox="1050 286 1378 322">1</td> </tr> <tr> <td data-bbox="384 322 727 358">Welding Machine</td> <td data-bbox="727 322 1050 358">500A</td> <td data-bbox="1050 322 1378 358">1</td> </tr> <tr> <td data-bbox="384 358 727 394">One Bagger Mixer</td> <td data-bbox="727 358 1050 394">4-6 cu.ft/min</td> <td data-bbox="1050 358 1378 394">1</td> </tr> <tr> <td data-bbox="384 394 727 461">Bar Bender</td> <td data-bbox="727 394 1050 461">20-mm. bending radius</td> <td data-bbox="1050 394 1378 461">1</td> </tr> <tr> <td data-bbox="384 461 727 497">Cutting Outfit</td> <td data-bbox="727 461 1050 497">-</td> <td data-bbox="1050 461 1378 497">1</td> </tr> <tr> <td data-bbox="384 497 727 533">Plate Compactor</td> <td data-bbox="727 497 1050 533">5 hp</td> <td data-bbox="1050 497 1378 533">1</td> </tr> <tr> <td data-bbox="384 533 727 568">Dump Truck</td> <td data-bbox="727 533 1050 568">12 cu.yd</td> <td data-bbox="1050 533 1378 568">1</td> </tr> </tbody> </table> <p data-bbox="384 607 1406 707">Availability of all the equipment listed herein shall always be ensured giving priority to this project and further committing that no delay shall transpire due to its absence whatsoever.</p> <p data-bbox="384 745 1406 813">Presentment of proof of ownership, lease, or possession of all the equipment effective within the duration of this project shall be made upon bid submission.</p>	Equipment	Minimum Specifications	Minimum Number of Units	Bar Cutter	20-mm. capacity	1	Welding Machine	500A	1	One Bagger Mixer	4-6 cu.ft/min	1	Bar Bender	20-mm. bending radius	1	Cutting Outfit	-	1	Plate Compactor	5 hp	1	Dump Truck	12 cu.yd	1
Equipment	Minimum Specifications	Minimum Number of Units																							
Bar Cutter	20-mm. capacity	1																							
Welding Machine	500A	1																							
One Bagger Mixer	4-6 cu.ft/min	1																							
Bar Bender	20-mm. bending radius	1																							
Cutting Outfit	-	1																							
Plate Compactor	5 hp	1																							
Dump Truck	12 cu.yd	1																							
12	Not applicable.																								
15.1	<p>The bid security shall be in the form of a Bid Securing Declaration or any of the following forms and amounts:</p> <ol style="list-style-type: none"> <li data-bbox="408 958 1406 1059">a. The amount of not less than <b>two percent (2%) of the ABC for each LOT</b>, if bid security is in cash, cashier's/manager's check, bank draft/guarantee, or irrevocable letter of credit;</li> <li data-bbox="408 1093 1406 1160">b. The amount of not less than <b>five percent (5%) of the ABC for each LOT</b> if bid security is in Surety Bond.</li> </ol>																								
16	<p>Each Bidder is requested to submit one (1) original copy and two (2) certified true copies certified by the owner or its duly authorized representative whose full name and designation should be indicated below the signature.</p> <p>With respect to the documents those are emanating from the bidder should be originally signed by the owner or its duly authorized representative, to wit: Statement of all ongoing government and private contract, Statement of Single Largest Completed Contract, Bid Securing Declaration, Technical Specifications, Omnibus Sworn Statement, Net Financial Contracting Capacity, Bid Form, Bill of Quantities, Detailed Estimates including summary sheet, and Cash Flow by Quarter.</p> <p>Each bidder shall submit its bid proposal to a one mother envelope that shall contain 3 more envelopes containing 3 copies of its technical and financial documents. Each of the 3 envelopes shall contain two more envelopes labeled as technical and financial components. The envelopes must be properly and separately marked and sealed.</p>																								
19.2	Partial bids are not allowed.																								
21	<p><b>The following documents shall be submitted by the winning bidder within ten (10) calendar days from receipt of the Notice of Award:</b></p> <ol style="list-style-type: none"> <li data-bbox="400 1966 699 1995">1. Program of Works</li> </ol>																								

2. Manpower schedule;
3. Equipment/tools utilization schedule;
4. Construction safety and health program approved by MOLE;
5. S-Curve; and
6. PERT-CPM.







**Section IV. General Conditions of Contract**

## 1. Scope of Contract

This Contract shall include all such items, although not specifically mentioned, that can be reasonably inferred as being required for its completion as if such items were expressly mentioned herein. All the provisions of RA No. 9184 and its 2016 revised IRR, including the Generic Procurement Manual, and associated issuances, constitute the primary source for the terms and conditions of the Contract, and thus, applicable in contract implementation. Herein clauses shall serve as the secondary source for the terms and conditions of the Contract.

This is without prejudice to Sections 74.1 and 74.2 of the 2016 revised IRR of RA No. 9184 allowing the GPPB to amend the IRR, which shall be applied to all procurement activities, the advertisement, posting, or invitation of which were issued after the effectivity of the said amendment.

## 2. Sectional Completion of Works

If sectional completion is specified in the **Special Conditions of Contract (SCC)**, references in the Conditions of Contract to the Works, the Completion Date, and the Intended Completion Date shall apply to any Section of the Works (other than references to the Completion Date and Intended Completion Date for the whole of the Works).

## 3. Possession of Site

3.1 The Procuring Entity shall give possession of all or parts of the Site to the Contractor based on the schedule of delivery indicated in the **SCC**, which corresponds to the execution of the Works. If the Contractor suffers delay or incurs cost from failure on the part of the Procuring Entity to give possession in accordance with the terms of this clause, the Procuring Entity's Representative shall give the Contractor a Contract Time Extension and certify such sum as fair to cover the cost incurred, which sum shall be paid by Procuring Entity.

3.2 If possession of a portion is not given by the above date, the Procuring Entity will be deemed to have delayed the start of the relevant activities. The resulting adjustments in contract time to address such delay may be addressed through contract extension provided under Annex "E" of the 2016 revised IRR of RA No. 9184.

## 4. The Contractor's Obligations

The Contractor shall employ the key personnel named in the Schedule of Key Personnel indicating their designation, in accordance with **ITB** Clause 10.3 and specified in the **BDS**, to carry out the supervision of the Works.

The Procuring Entity will approve any proposed replacement of key personnel only if their relevant qualifications and abilities are equal to or better than those of the personnel listed in the Schedule.

## **5. Performance Security**

5.1. Within ten (10) calendar days from receipt of the Notice of Award from the Procuring Entity but in no case later than the signing of the contract by both parties, the successful Bidder shall furnish the performance security in any of the forms prescribed in Section 39 of the 2016 revised IRR.

5.2. The Contractor, by entering into the Contract with the Procuring Entity, acknowledges the right of the Procuring Entity to institute action pursuant to RA No. 3688 against any subcontractor be they an individual, firm, partnership, corporation, or association supplying the Contractor with labor, materials and/or equipment for the performance of this Contract.

## **6. Site Investigation Reports**

The Contractor, in preparing the Bid, shall rely on any Site Investigation Reports referred to in the SCC supplemented by any information obtained by the Contractor.

## **7. Warranty**

7.1. In case the Contractor fails to undertake the repair works under Section 62.2.2 of the 2016 revised IRR, the Procuring Entity shall forfeit its performance security, subject its property(ies) to attachment or garnishment proceedings, and perpetually disqualify it from participating in any public bidding. All payables of the GOP in his favor shall be offset to recover the costs.

7.2. The warranty against Structural Defects/Failures, except that occasioned-on force majeure, shall cover the period from the date of issuance of the Certificate of Final Acceptance by the Procuring Entity. Specific duration of the warranty is found in the SCC.

## **8. Liability of the Contractor**

Subject to additional provisions, if any, set forth in the SCC, the Contractor's liability under this Contract shall be as provided by the laws of the Republic of the Philippines.

If the Contractor is a joint venture, all partners to the joint venture shall be jointly and severally liable to the Procuring Entity.

## **9. Termination for Other Causes**

Contract termination shall be initiated in case it is determined prima facie by the Procuring Entity that the Contractor has engaged, before, or during the

implementation of the contract, in unlawful deeds and behaviors relative to contract acquisition and implementation, such as, but not limited to corrupt, fraudulent, collusive, coercive, and obstructive practices as stated in **ITB** Clause 4.

## **10. Dayworks**

Subject to the guidelines on Variation Order in Annex “E” of the 2016 revised IRR of RA No. 9184, and if applicable as indicated in the **SCC**, the Dayworks rates in the Contractor’s Bid shall be used for small additional amounts of work only when the Procuring Entity’s Representative has given written instructions in advance for additional work to be paid for in that way.

## **11. Program of Work**

11.1. The Contractor shall submit to the Procuring Entity’s Representative for approval the said Program of Work showing the general methods, arrangements, order, and timing for all the activities in the Works. The submissions of the Program of Work are indicated in the **SCC**.

11.2. The Contractor shall submit to the Procuring Entity’s Representative for approval an updated Program of Work at intervals no longer than the period stated in the **SCC**. If the Contractor does not submit an updated Program of Work within this period, the Procuring Entity’s Representative may withhold the amount stated in the **SCC** from the next payment certificate and continue to withhold this amount until the next payment after the date on which the overdue Program of Work has been submitted.

## **12. Instructions, Inspections and Audits**

The Contractor shall permit the GOP or the Procuring Entity to inspect the Contractor’s accounts and records relating to the performance of the Contractor and to have them audited by auditors of the GOP or the Procuring Entity, as may be required.

## **13. Advance Payment**

The Procuring Entity shall, upon a written request of the Contractor which shall be submitted as a Contract document, make an advance payment to the Contractor in an amount not exceeding fifteen percent (15%) of the total contract price, to be made in lump sum, or at the most two installments according to a schedule specified in the **SCC**, subject to the requirements in Annex “E” of the 2016 revised IRR of RA No. 9184.

## **14. Progress Payments**

The Contractor may submit a request for payment for Work accomplished. Such requests for payment shall be verified and certified by the Procuring Entity’s Representative/Project Engineer. Except as otherwise stipulated in the **SCC**,



materials and equipment delivered on the site but not completely put in place shall not be included for payment.

## 15. Operating and Maintenance Manuals

15.1. If required, the Contractor will provide “as built” Drawings and/or operating and maintenance manuals as specified in the **SCC**.

15.2. If the Contractor does not provide the Drawings and/or manuals by the dates stated above, or they do not receive the Procuring Entity’s Representative’s approval, the Procuring Entity’s Representative may withhold the amount stated in the **SCC** from payments due to the Contractor.





## **Section V. Special Conditions of Contract**

## Special Conditions of Contract

GCC Clause	
2	n/a
4.1	n/a
7.2	Fifteen (15) years.
10	Dayworks are applicable at the rate shown in the Contractor's original Bid.
11.1	The Contractor shall submit the <b>Program of Work</b> to the Procuring Entity's Representative within <b>ten (10)</b> days of delivery of the Notice of Award.
11.2	The amount to be withheld for late submission of an updated Program of Work is [insert amount].
13	The amount of the advance payment <b>shall not exceed 15% of the total contract price and schedule of payment.</b>
14	Materials and equipment delivered on the site but not completely put in place shall not be included for payment.
15.1	The date by which operating and maintenance manuals are required <b>upon substantial completion.</b>  The date by which "as built" drawings are required <b>upon substantial completion.</b>
15.2	The amount to be withheld for failing to produce "as built" drawings and/or operating and maintenance manuals by the date required is [amount in local currency].

## **Section VI. Specifications**

## INTRODUCTION

The Drawings/Plans and Specifications are complementary to each other. Drawings are graphic means of showing work to be done. They are particularly suited to showing where materials are located. Thus, drawings exist essentially to show dimension, location, and placement. Not all works, however, can be presented in the drawings. Generalized works are usually in statement form and hence, the contractor is required to read the Specifications carefully.

Specifications, on the other hand, are used to describe the materials, construction techniques, samples, shop drawings, guarantees, and other contract requirements. Together, the drawings and the Specifications are used to inform the contractor. In cases where the specified brand carries the manufacturer's specifications, the manufacturer's specifications shall hold precedence over these Specifications.

The following are the underlying principles of these Specifications:

1. The technical Specifications are only one part of the Contract Documents;
2. The Contract is between the Procuring Entity and the General Contractor; and
3. The General Contractor is the only party responsible for completing the work in accordance with the Contract Documents.

Therefore:

1. Only the General Contractor is referred to in the Specifications so as not to violate the intent of the contract and so as not to undermine the proper chain of command.
2. Any reference to Specialty Trade Contractors in the technical Specifications is made only insofar as the selection of Specialty Trade Contractors is made through bidding. Once the Specialty Trade Contractors are selected and assigned to the General Contractor, the General Contractor assumes all the responsibilities for the execution of the whole project in accordance with the Contract Documents. Therefore, in the contract between the Owner and the General Contractor, the Specialty Trade Contractor is not referred to. In all contract Documents, the word "Contractor" means the General Contractor.
3. The brand names specified are intended to assure the level of quality needed for the project. This does not mean however that the brands specified are exclusive. The Contractor shall prove by laboratory tests and certificates that substitute materials are of the equivalent quality and the Contractor shall secure the Architect's approval prior to use of such substitutes.
4. The omission of the phrase "The Contractor shall" is intentional because the whole Specifications are directed to the Contractor. Omitted words or phrases shall be



supplied by inference in the same manner as they are when a “note” occurs on the plans.

5. Where “as shown,” “as indicated,” “as detailed” or words of similar import are used, it shall be understood that reference to the plans accompanying the Specifications is made unless otherwise stated.
6. Where “as directed “, “as required,” “as permitted,” “as authorized,” “as approved, accepted” or words of similar import as used, it shall be understood that the direction, requirements, permission, authorization, approval, or acceptance of the Architect is intended unless otherwise stated.
7. As used herein, “provided” shall be understood to mean “provided complete in place,” that is, “furnished and installed.”
8. Most sentences are in the imperative mood. This style is especially suited for instructions covering the installation of products and equipment.

## **CLARIFICATIONS**

All reference to any brand, material, equipment, or systems in the Specifications, plans, and bid documents is indicative of the type and quality of what is required. However, any equal material, equipment, or system can be used.

The list of items of work provided in the scope of works does not in any way limit the responsibility of the Contractor to perform all other works necessary for the completion of the project.

### **A. GENERAL CONDITIONS DESCRIPTION OF THE PROJECT**

Complete all works for the Construction of One (1)-Unit Covered Court in Sitio Sayugan Interior, Brgy. Maligaya, Lamitan City, Basilan, including the supply of all materials, equipment, and systems, as well as the performance of all necessary labor and processes, in accordance with the plans, the Bidding Documents, the Terms of References, and other related contract documents.

The contractor is not limited to the scope of works listed. They should verify all plans and actual conditions for the necessity of work. If the actual situation calls for demolition, removal, and relocation, he shall include such and all concomitant works to finish as part of the scope of work.

Any discrepancies found between the plans and Specifications and the site conditions or any errors or omissions in the plans or Specifications should be clarified with the Consultant/Engineer/ Representative from the Procuring Entity.

Should the contractor fail to verify or clarify discrepancies, errors, conflicts, or omissions in the plans and Specifications, it shall be deemed that the contractor has included in the preparation of his bid the necessary works, materials, or items needed to satisfy the general scope of works.

## **B. SCOPE OF WORK**

### **1. General Requirements**

- 1.1 Furnish all materials, equipment, tools, apparatus, appliances, accessories, transportation, labor, and supervision required for the complete construction of the subject project, as shown on the plans and called for on these Specifications, ready for use.
- 1.2 Inspect the site of works before submitting a proposal for this project. All proposals shall take into consideration all such conditions that may affect the work under this contract. The Specifications and plans shall form part of one. Anything mentioned on the plans and not mentioned on the scope of work and Specifications and vice versa shall be properly consulted to the Procuring Entity Project Architect/Engineer for clarification. Any work or materials not in accordance with the plans or Specifications shall be replaced to comply with the plans and Specifications at the Contractor's expense.
- 1.3 Coordinate work with all parties to ensure proper phasing or compliance with the approved schedule of work. Engage a registered Engineer or Architect to supervise his work. He shall remain at all times in the construction site.
- 1.4 A logbook shall be available at the site. It shall contain the daily activities on the site, including but not limited to weather conditions, delivery, manpower, and other matters pertaining to the condition of the project. It will also serve as the data for the contractor and the Project Inspector and shall be surrendered to the Procuring Entity at the end of the project.
- 1.5 Daily accomplishment reports shall be prepared, supported with progress photographs and S-curves to monitor actual progress status reports and to be used as the basis for progress billing.
- 1.6 Submit additional detailed plans and analyses as required, which are necessary for the faithful completion of the works.
- 1.7 No alteration or additional work that will result in an additive or deductive cost change from the Contract shall be allowed without the approval of the Head of the Procuring Entity.

- 1.8 Inspection of the Project Engineer/Architect in charge shall be required prior to the installation of any item/material on the construction.
- 1.9 Regular coordination meetings shall be conducted with the OCM and the SDF-PMO, Contractor, and Owner/End-user for proper project monitoring.
- 1.10 Existing conditions of the work site shall be documented by the contractor and photos shall be taken before the commencement of work to ensure such status. Any damage to the areas due to the Contractor's ongoing work shall be restored at his expense.
- 1.11 Promptly remove from the premises all rubbish, trash, debris, and all superfluous building materials weekly. After the completion of all works, restore all areas that were damaged or affected by the construction works and leave the site clean to the satisfaction of the Project Inspector or his representative and the Owner/End-user.
- 1.12 All materials removed from the unit shall be properly documented prior to turn-over to the Owner/End-user for proper safekeeping. The turnover document shall be attached to the contractor's final billing.

## 2. Mobilization/Demobilization

- 2.1 Mobilize and bring out into work, all personnel, plant, and equipment, in accordance with his approved construction program, equipment moving and utilization schedule, and manpower schedule, from its regular place of business to the site to undertake the contract.
- 2.2 Mobilization shall include the obtaining and transporting to the site of the equipment, materials, tools, personnel, construction plant, and all necessary items for the execution and completion of the work and shall also include the setting up and verification of all equipment, instrument, and all other plants until it is rendered operable.
- 2.3 It shall also include sufficient supply of spare parts for the construction plant. Breakdowns are to be repaired on-site by the most expeditious method possible at no cost to the Procuring Entity. In the event, that repairs are beyond the personnel or tools at the site to effect repairs in a reasonable time, such that the construction plant must be removed from the site, then a replacement of machine or plant or equipment of a similar capacity shall be provided by the contractor at no additional mobilization costs to the Procuring Entity nor extension of completion of works.
- 2.4 Demobilization shall include dismantlement and removal from the site of the Contractor's plant, materials and equipment, and all temporary facilities. It shall also include clean-up of the site after completion of the contract as

approved by the Project Manager and transportation from the site of the Contractor's personnel.

### 3. Permits/Temporary Facilities

- 3.1 Provide and maintain field office/s including all the necessary utilities such as electricity, water, drainage, security, safety requirements, and other temporary works necessary for the successful completion of the work. The cost for all the utilities shall be borne by the Contractor.
- 3.2 Temporary facilities shall have sufficient area that will accommodate the offices for the Contractor and the Procuring Entity's representative, a storage area, complete with toilet fixtures and interior finishes.
- 3.3 Temporary facilities shall include a stockpile area for bulky construction materials. The ground area shall be appropriately maintained, improved, and leveled to provide mobility and easy access for identification and inspection of materials.
- 3.4 The facilities shall conform to the best standard for the required types and shall include office equipment, apparatus, pieces of furniture, and other tools necessary for the prosecution of the work.
- 3.5 Provide all necessary safety tools, identifications, uniforms, and equipment for the workers and staff in accordance with the Safety Standard. Provide construction safety barricades along the perimeter of and/or within the project site. The type and material of these barricades shall be subject to the approval of the Procuring Entity.
- 3.6 Temporary facilities shall be dismantled and removed from the site after completion of the contract.

### 4. Earthworks

- 4.1 *Site Clearing.* Debris, shrubs, and other unsuitable materials shall be removed.
- 4.2 *Cut and Fill.* Cut and fill shall be done to elevations where required.
- 4.3 *Stakeout.* All lines and grades as shown on the plans will be established before the excavation is started. Basic batter boards and reference works shall be placed at such place where they will not be disturbed during foundation works.

4.4 *Excavation*. Excavation for foundations shall be made to grades as indicated on plans. Excavations shall be made deeper until the general or desired stratum for the safe bearing capacity of soil is reached.

4.5 *Backfill*. Works include backfilling and compaction of excavated materials.

4.6 *Gravel fill*. Works include filling of 50mm thick layer of gravel at column footings and footing tie beams prior to concrete pouring.

4.7 *Pest Control/ Soil Poisoning*. Work includes furnishing and applying termite control chemicals, including the use of equipment and tools in performing such operations in accordance with the Specification.

## 5. Concrete Works

5.1 *Concreting*. Works include concreting of column footings, footing tie beams, columns, beams, and slabs as specified in the plans and Specifications.

5.2 *Reinforcing Steel Bars (RSB)*. Works include the provision of reinforcing bars for footings, footing tie beams, columns, beams, and slabs as specified in the plans and Specifications, all sizes of reinforcing bars shall be as specified in the plans.

5.3 *Formworks*. Works include the provision of formworks and falseworks for all concrete works.

## 6. Masonry Works

6.1 *CHB Laying*. Work includes laying of 100mm and 150mm thick CHB, and mortar and filler, as specified in the plans and Specifications.

6.2 *Plastering Works*. Provide plain cement finish as specified in the plans and Specifications.

## 7. Roofing Works

7.1 *Roof Framing*. Supply and install trusses, fascia board, and other roof structures in accordance with plans and as herein specified.

7.2 *Roofing and Tinsmithry*. Supply and install roofing sheets, gutters, ridge roll, flashing, and other roof accessories in accordance with plans and as herein specified.

## 9. Finishing Works

9.1 *Paints and Coatings*. Furnish all paints, enamels, varnishes, and other products to be used including labor, tools, and equipment required as shown



on the plans and in accordance with these Specifications. Upon completion of the project, all paint spots from all finished works shall be removed. Clean off all glass from paint spots, smears, and blemishes.

#### 10. Fabricated Materials and Hardware

This includes the fabrication and installation of basketball ring, post, and board as specified in the plans and Specifications.

### **C. SPECIFICATIONS**

All plans - small scale and detail drawings, are intended to collaborate with the Specifications and to form a part thereof, where figures are given, they are to be followed in preference to measurement by scale. Anything shown in the plans and not mentioned in the Specifications or vice-versa or anything not expressly set forth in either, but which is reasonably implied shall be furnished and installed as thought specifically shown in mentioned both.

#### 1. Primary Specifications

The DPWH Standard Specifications for Public Works and Highways (“Blue Book”) shall be the main basis for the standards and codes to be met by the goods and materials to be furnished and work performed or tested for the Contract. In particular, Volume III of the Blue Book shall be used. The Blue Book incorporates standards of the American Association of State Highway and Transportation Officials (AASHTO), American Society for Testing and Materials (ASTM), and American Concrete Institute (ACI), among others, pertaining to construction.

### **D. GUARANTEE**

The Contractor shall guarantee all works under these Specifications to be free from any technical, material, workmanship, and/or factory defects and shall replace and repair to the satisfaction of the Project Architect/Engineer of the Procuring Entity in any part or portion of the work which may fail within a period of one (1) year after the final acceptance of the project.

### **E. OTHERS**

The Contractor must have a Project Engineer who will supervise the project onsite. The Contractor shall inform the Procuring Entity in case of replacement/changes of personnel assigned at the project site. The replacement must have relevant qualifications and abilities equal to or better than those of the personnel as evidenced by his/her training certification to be submitted to GSD.

Demolitions and repairs due to the Contractor’s fault shall be done by the Contractor without extra compensation to the Owner.

As soon as the project is satisfactorily inspected and it conforms to the plans and Specifications, the Contractor shall submit to the Procuring Entity a written notice that said project is completed and is subject to the latter's approval.

Five copies of "As-Built Plans" must be submitted not later than 7 days after project completion.

## ***Section VII. Drawings***

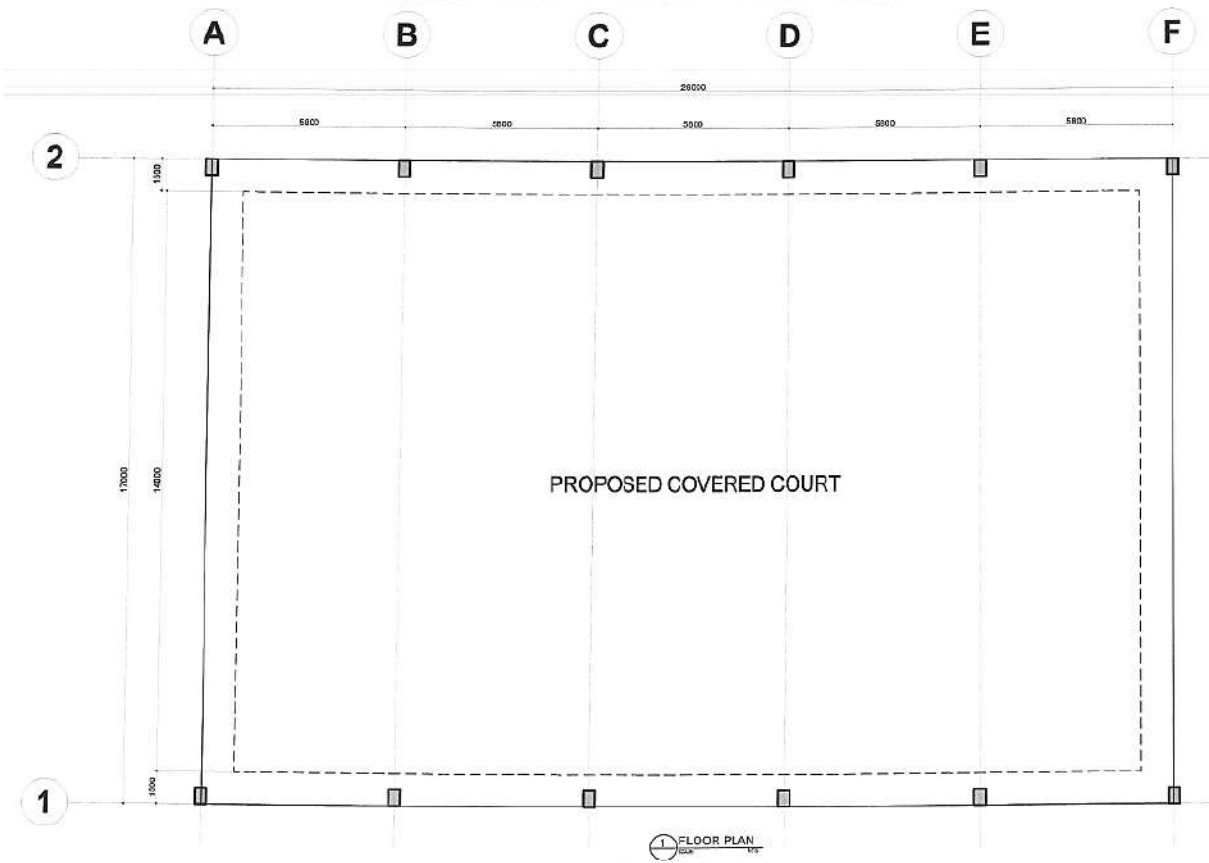
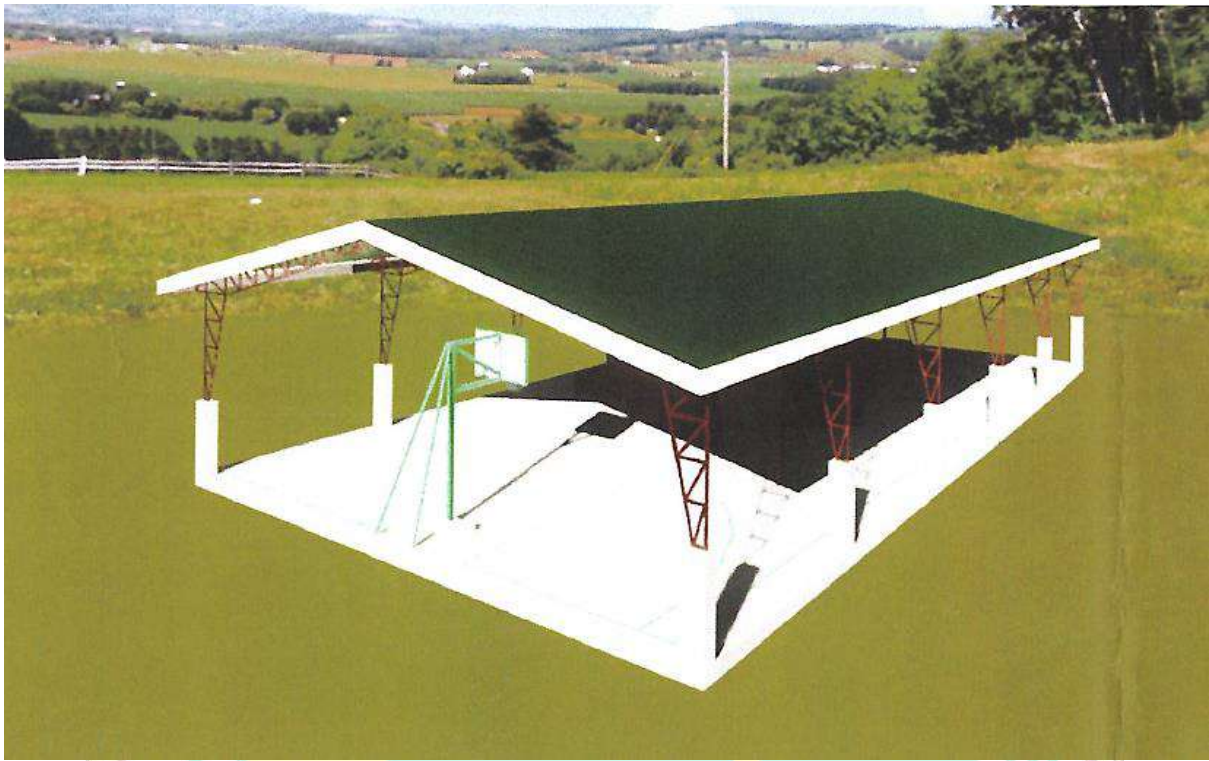



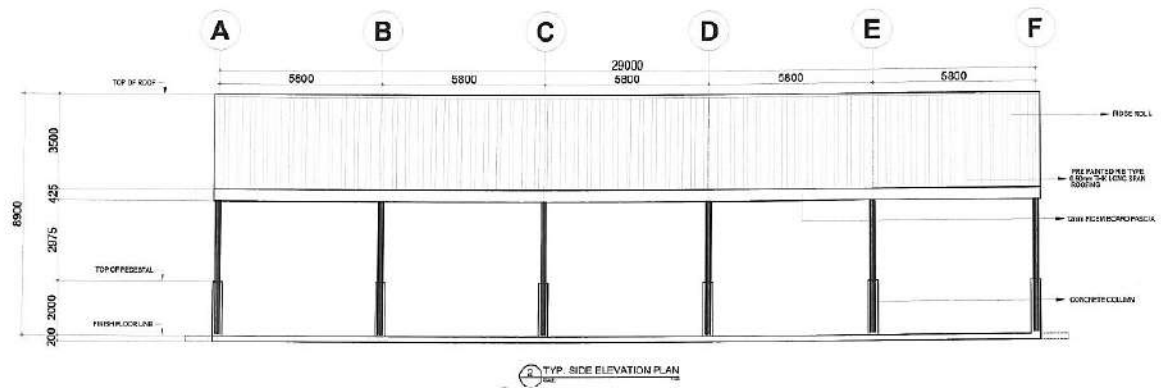
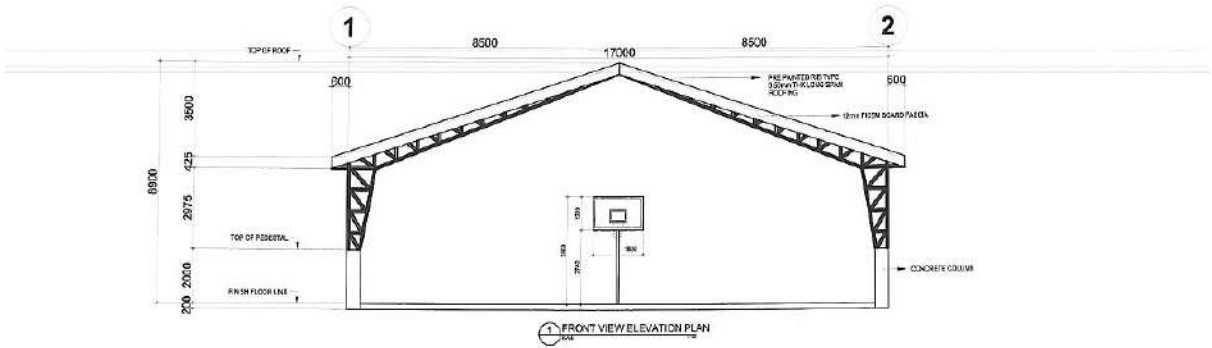
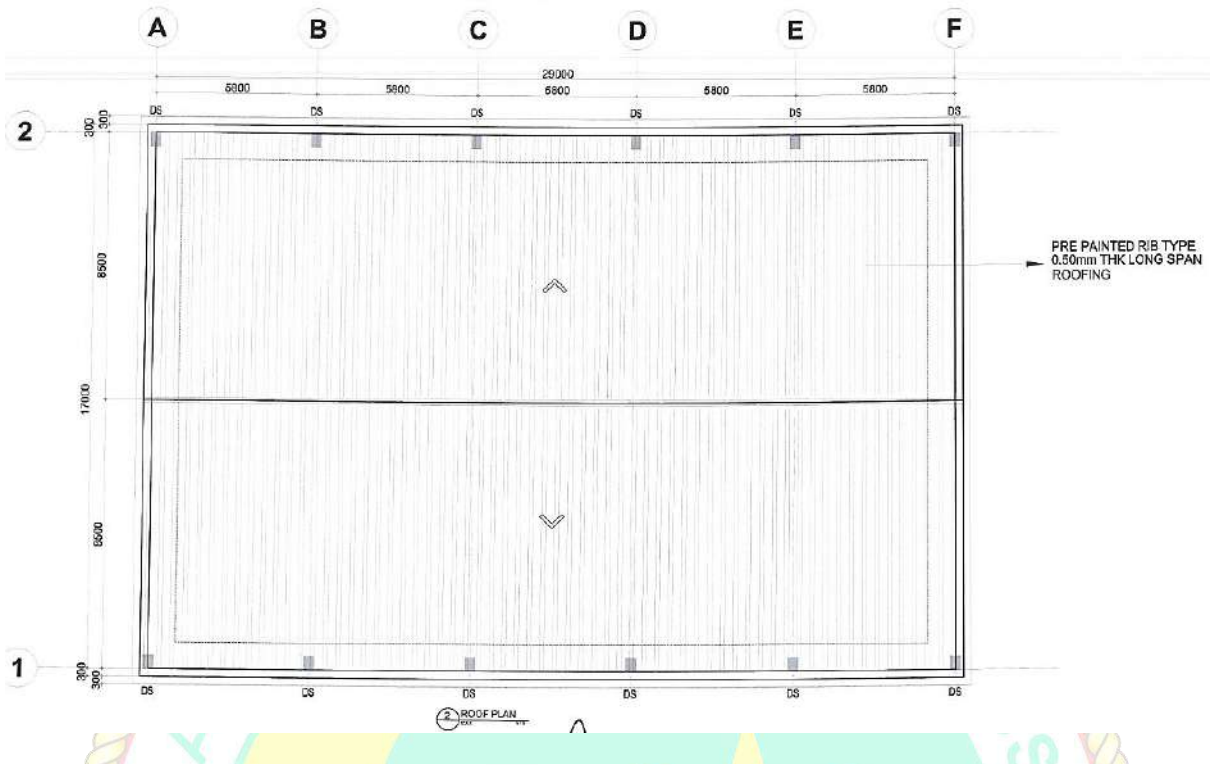

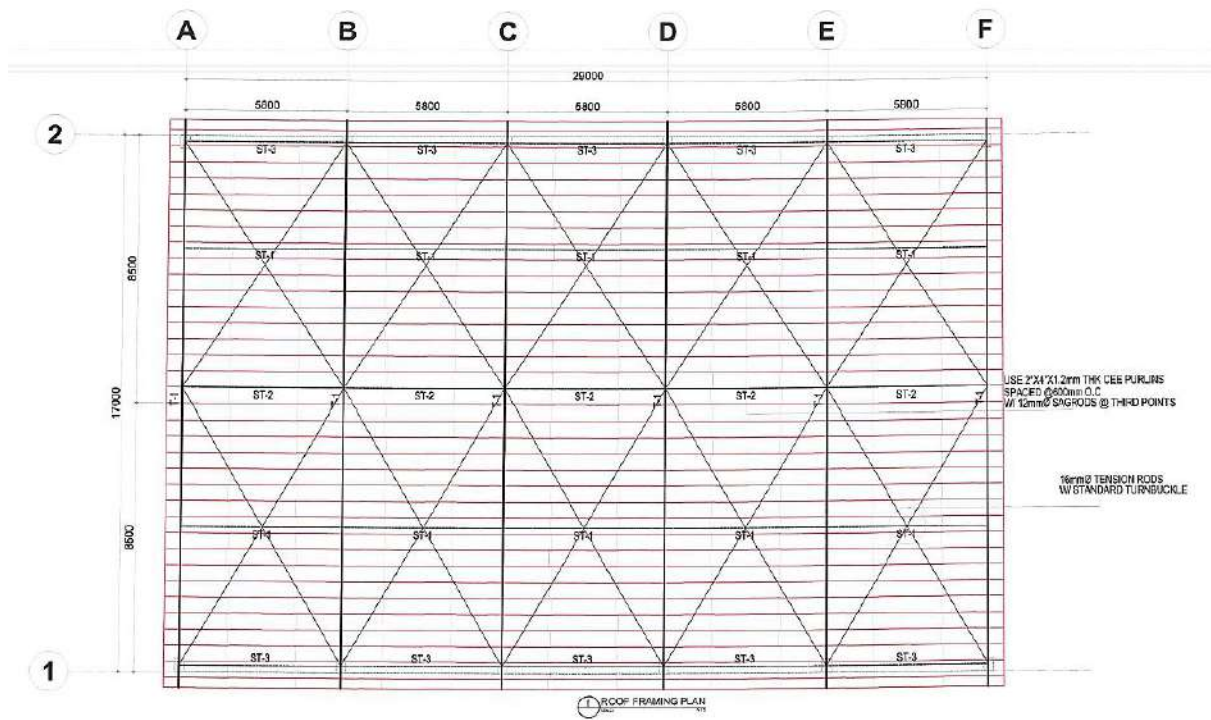
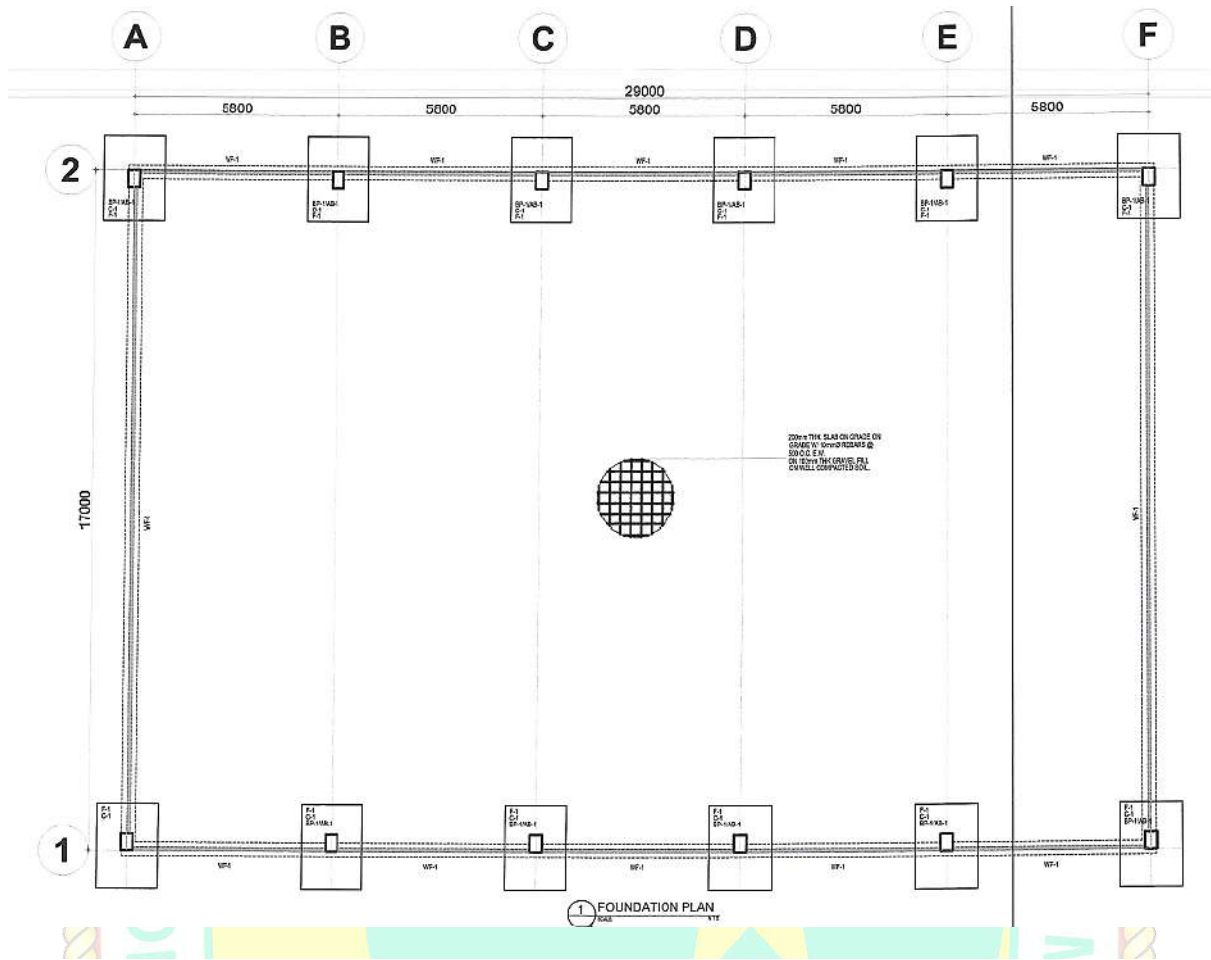

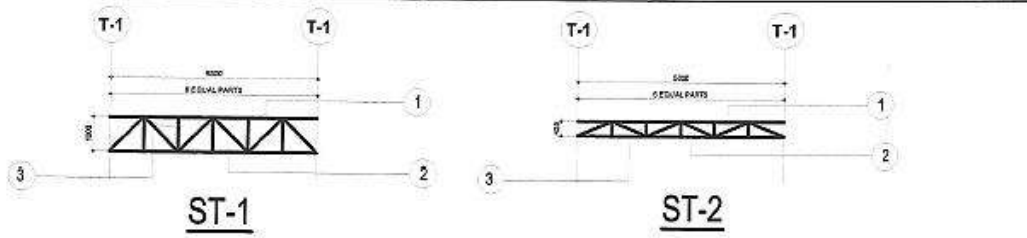
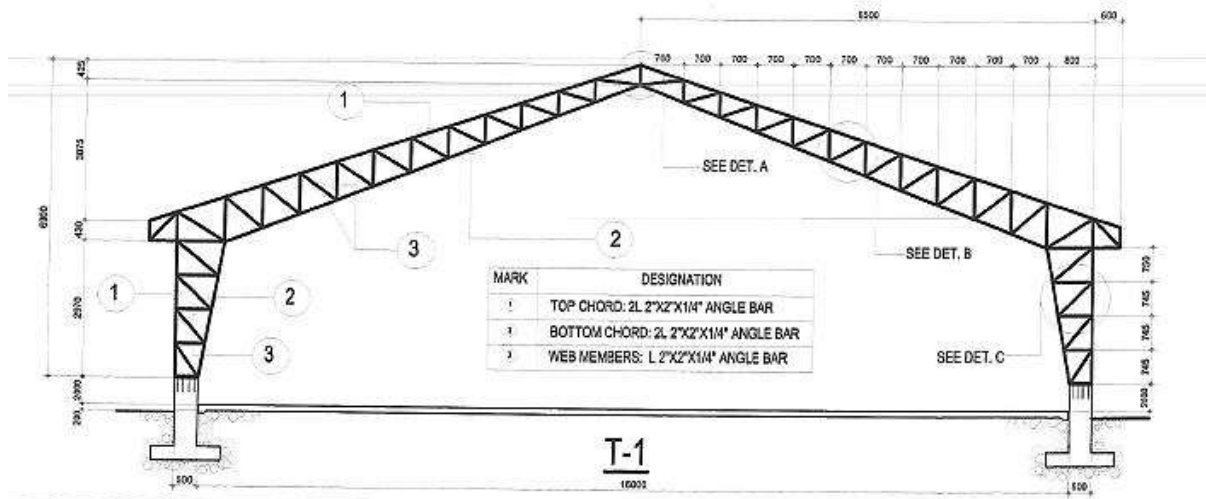

1 SCHEDULE OF TRUSS

NOTE: 1.) USE 10mm THK GUSSET PLATE AT EVERY INTERSECTION OF WEB MEMBERS AND MAIN MEMBERS

MARK	DESIGNATION
1	TOP CHORD: 2L 1 1/2" X 1 1/2" X 3/16" ANGLE BAR
2	BOTTOM CHORD: 2L 1 1/2" X 1 1/2" X 3/16" ANGLE BAR
3	WEB MEMBERS: 1 1/2" X 1 1/2" X 3/16" ANGLE BAR

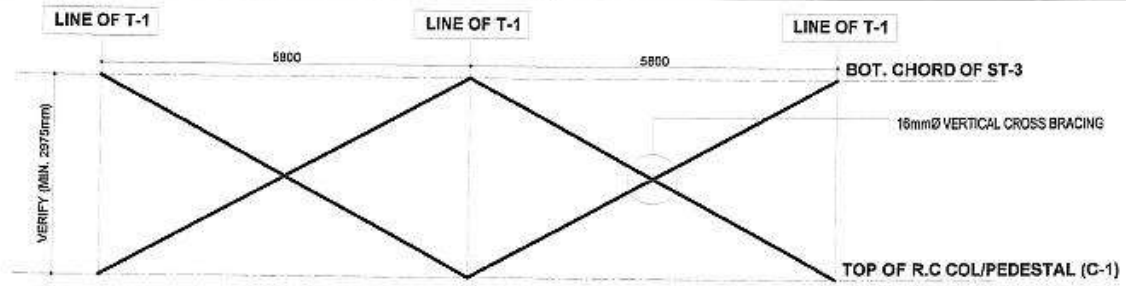

B TYP. DET. OF VERT. CROSS BRACING



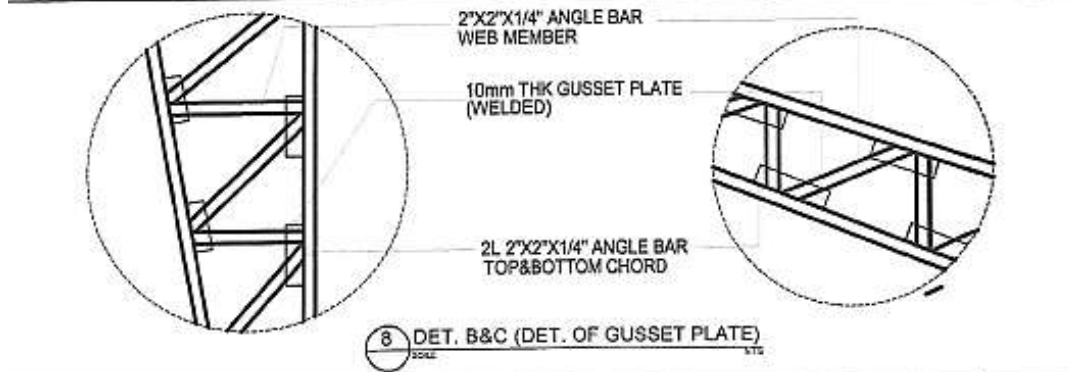
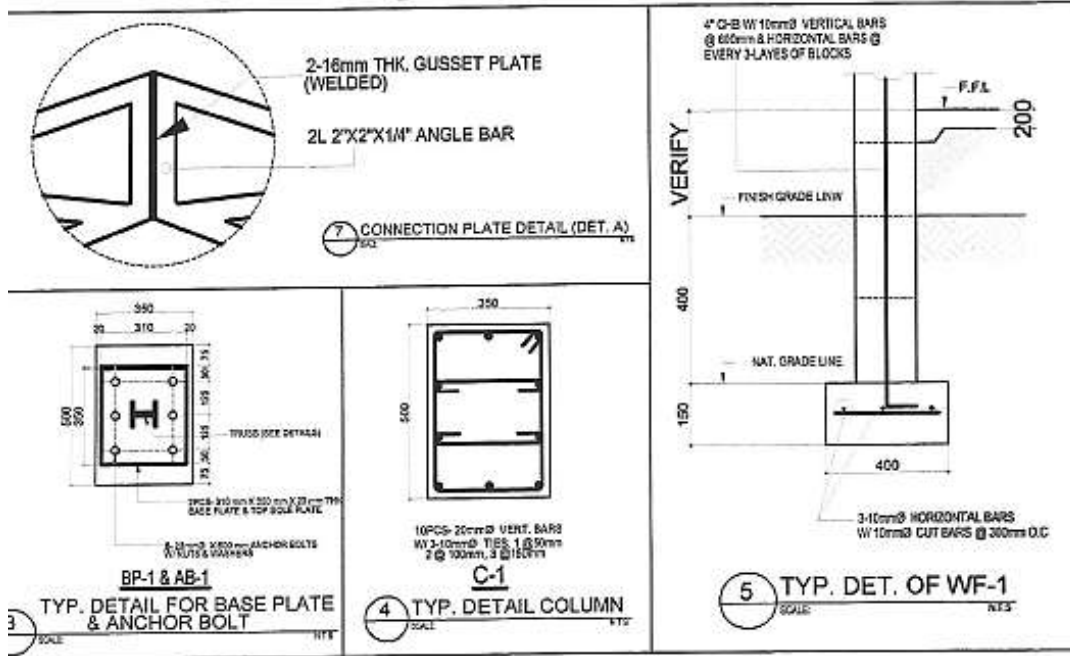
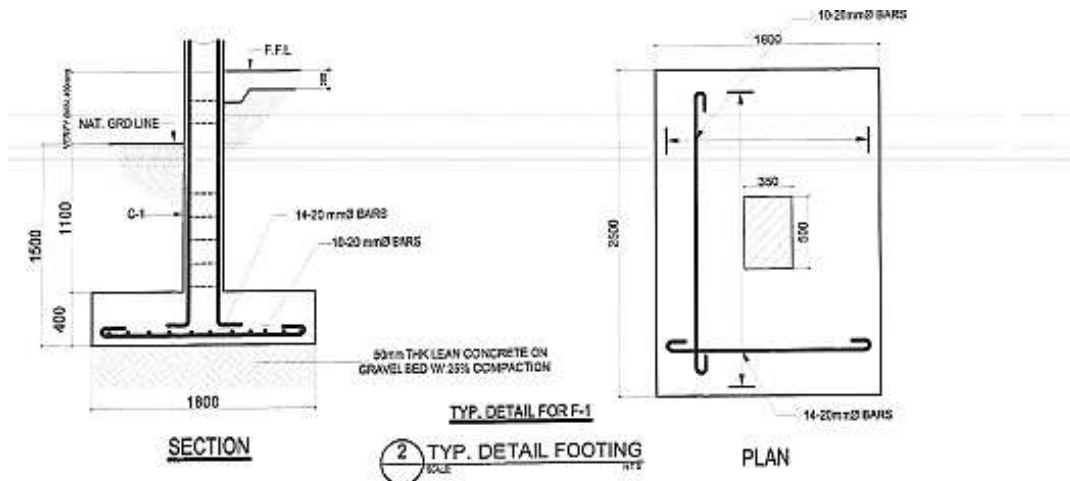



## Section VIII. Bill of Quantities

Contract Name: Construction of One (1)-Unit Covered Court

Location of the Contract: Sitio Sayugan Interior, Brgy. Maligaya, Lamitan City, Basilan

ITEM NO.	DESCRIPTION	UNIT	QUANTITY	UNIT PRICE (Pesos)	AMOUNT (Pesos)
(1)	(2)	(3)	(4)	(5)	(6)
<b>PART I. FACILITIES FOR THE ENGINEER</b>					
A.1.1(8)	Provision of Field Office for the Engineer (Rental)	LS	1.00	In Words: Pesos: _____ _____ _____ In Figures: _____ _____	In Words: Pesos: _____ _____ _____ In Figures: _____ _____
<b>PART II. OTHER GENERAL REQUIREMENTS</b>					
B.3	Permits and Clearances	L.S.	1.00	In Words: Pesos: _____ _____ _____ In Figures: _____ _____	In Words: Pesos: _____ _____ _____ In Figures: _____ _____
B.5	Project Billboard/Signboard	Ea	3.00	In Words: Pesos: _____ _____ _____ In Figures: _____ _____	In Words: Pesos: _____ _____ _____ In Figures: _____ _____
B.7(2)	Occupational Safety and Health	L.S.	1.00	In Words: Pesos: _____ _____ _____ In Figures: _____ _____	In Words: Pesos: _____ _____ _____ In Figures: _____ _____
B.9	Mobilization /Demobilization	L.S.	1.00	In Words: Pesos: _____ _____ _____ In Figures: _____ _____	In Words: Pesos: _____ _____ _____ In Figures: _____ _____

**PART III. CIVIL, MECHANICAL, ELECTRICAL AND SANITARY/PLUMBING WORKS**

800(1)	Clearing and Grubbing	sq.m.	493.00	In Words: Pesos: _____ _____ _____ In Figures: _____	In Words: Pesos: _____ _____ _____ In Figures: _____
803(1)a	Structure Excavation (Common Soil)	cu.m.	173.00	In Words: Pesos: _____ _____ _____ In Figures: _____	In Words: Pesos: _____ _____ _____ In Figures: _____
804(1)a	Embankment from Common Borrow by Equipment	cu.m.	95.00	In Words: Pesos: _____ _____ _____ In Figures: _____	In Words: Pesos: _____ _____ _____ In Figures: _____
804(4)	Gravel Bedding	cu.m.	7.00	In Words: Pesos: _____ _____ _____ In Figures: _____	In Words: Pesos: _____ _____ _____ In Figures: _____
900(1)c2	Structural Concrete Footings and Slab on Fill (Class A, 28 days)	cu.m.	82.30	In Words: Pesos: _____ _____ _____ In Figures: _____	In Words: Pesos: _____ _____ _____ In Figures: _____
902(1)a	Reinforcing Steel of Reinforced Concrete Structure for One Storey, Grade 40/ Grade 60	kg.	2,217.68	In Words: Pesos: _____ _____ _____ In Figures: _____	In Words: Pesos: _____ _____ _____ In Figures: _____
903(2)	Formworks and Falseworks (for One-storey Building)	sq.m.	32.87	In Words: Pesos: _____ _____ _____ In Figures: _____	In Words: Pesos: _____ _____ _____ In Figures: _____

1014	Prepainted Metal Sheets (Corrugated, Short Span/Long Span)	sq.m.	527.00	In Words: Pesos: _____ _____ _____ In Figures: _____	In Words: Pesos: _____ _____ _____ In Figures: _____
1032(1)c	Painting Works (Metal Painting)	sq.m.	140.00	In Words: Pesos: _____ _____ _____ In Figures: _____	In Words: Pesos: _____ _____ _____ In Figures: _____
1046	100mm CHB Non-load Bearing (including Reinforcing Steel)	sq.m.	88.00	In Words: Pesos: _____ _____ _____ In Figures: _____	In Words: Pesos: _____ _____ _____ In Figures: _____
1047(2)b	Structural Steel Roof Truss	kg.	7,668.62	In Words: Pesos: _____ _____ _____ In Figures: _____	In Words: Pesos: _____ _____ _____ In Figures: _____
1047(2)c	Structural Steel Purlins	kg.	2,297.00	In Words: Pesos: _____ _____ _____ In Figures: _____	In Words: Pesos: _____ _____ _____ In Figures: _____
1047(3)a	Metal Structure Accessories (Anchor Bolts)	pc	72.00	In Words: Pesos: _____ _____ _____ In Figures: _____	In Words: Pesos: _____ _____ _____ In Figures: _____
1047(3)b	Metal Structure Accessories (Sag Rods)	pc	37.00	In Words: Pesos: _____ _____ _____ In Figures: _____	In Words: Pesos: _____ _____ _____ In Figures: _____

1047(3)c	Metal Structure Accessories (Turnbuckle)	pc	20.00	In Words: Pesos: _____ _____ _____ In Figures: _____	In Words: Pesos: _____ _____ _____ In Figures: _____
1047(3)d	Metal Structure Accessories (Cross Bracing)	pc	20.00	In Words: Pesos: _____ _____ _____ In Figures: _____	In Words: Pesos: _____ _____ _____ In Figures: _____
1047(5)	Metal Structure Accessories (Steel Plates)	kg	515.00	In Words: Pesos: _____ _____ _____ In Figures: _____	In Words: Pesos: _____ _____ _____ In Figures: _____
SPL-1	Basketball Ring, Post and Board	m.	2.00	In Words: Pesos: _____ _____ _____ In Figures: _____	In Words: Pesos: _____ _____ _____ In Figures: _____

AMOUNT IN WORDS:

\_\_\_\_\_

\_\_\_\_\_

\_\_\_\_\_

Submitted by:

\_\_\_\_\_ Date: \_\_\_\_\_

Name & Signature of Bidder's Representative

\_\_\_\_\_

Position

\_\_\_\_\_

Name of Firm

\_\_\_\_\_

Address

## Section IX. Checklist of Technical and Financial Documents

### Notes on the Checklist of Technical and Financial Documents

The prescribed documents in the checklist are mandatory to be submitted in the Bid, but shall be subject to the following:

- a. GPPB Resolution No. 09-2020 on the efficient procurement measures during a State of Calamity or other similar issuances that shall allow the use of alternate documents in lieu of the mandated requirements; or
- b. any subsequent GPPB issuances adjusting the documentary requirements after the effectivity of the adoption of the PBDs.

The BAC shall be checking the submitted documents of each Bidder against this checklist to ascertain if they are all present, using a non-discretionary “pass/fail” criterion pursuant to Section 30 of the 2016 revised IRR of RA No. 9184.

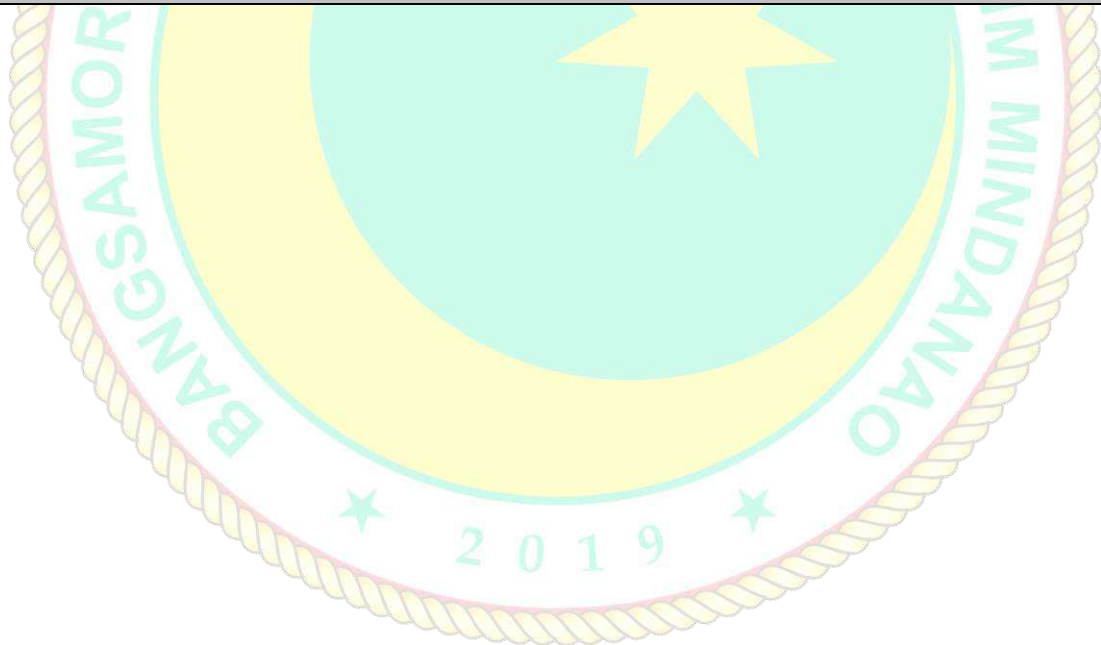



# Checklist of Technical and Financial Documents

## I. TECHNICAL COMPONENT ENVELOPE

### Class "A" Documents

#### Legal Documents

- (a) Valid PhilGEPS Registration Certificate (Platinum Membership) (all pages) in accordance with Section 8.5.2 of the IRR;

#### Technical Documents

- (e) Statement of the prospective bidder of all its ongoing government and private contracts, including contracts awarded but not yet started, if any, whether similar or not similar in nature and complexity to the contract to be bid; **and**
- (f) Statement of the bidder's Single Largest Completed Contract (SLCC) similar to the contract to be bid, except under conditions provided under the rules; **and**
- (g) Special PCAB License in case of Joint Ventures **and** registration for the type and cost of the contract to be bid; **and**
- (h) Original copy of Bid Security. If in the form of a Surety Bond, submit also a certification issued by the Insurance Commission **or** original copy of Notarized Bid Securing Declaration; **and**
- (i) Project Requirements, which shall include the following:
- a. Organizational chart for the contract to be bid;
- b. List of contractor's key personnel (*e.g.*, Project Manager, Project Engineers, Materials Engineers, and Foremen), to be assigned to the contract to be bid, with their complete qualification and experience data;
- c. List of contractor's major equipment units, which are owned, leased, and/or under purchase agreements, supported by proof of ownership or certification of availability of equipment from the equipment lessor/vendor for the duration of the project, as the case may be; **and**
- (j) Original duly signed Omnibus Sworn Statement (OSS) **and** if applicable, Original Notarized Secretary's Certificate in case of a corporation, partnership, or cooperative; or Original Special Power of Attorney of all members of the joint venture giving full power and authority to its officer to sign the OSS and do acts to represent the Bidder.

#### Financial Documents

- (k) The prospective bidder's computation of Net Financial Contracting

Capacity (NFCC).

**Class "B" Documents**

- (l) If applicable, duly signed joint venture agreement (JVA) in accordance with RA No. 4566 and its IRR in case the joint venture is already in existence **or** duly notarized statements from all the potential joint venture partners stating that they will enter into and abide by the provisions of the JVA in the instance that the bid is successful.

**II. FINANCIAL COMPONENT ENVELOPE**

- (m) Original of duly signed and accomplished Financial Bid Form; **and**

Other documentary requirements under RA No. 9184

- (n) Original of duly signed Bid Prices in the Bill of Quantities; **and**
- (o) Duly accomplished Detailed Estimates Form, including a summary sheet indicating the unit prices of construction materials, labor rates, and equipment rentals used in coming up with the Bid; **and**
- (p) Cash Flow by Quarter.

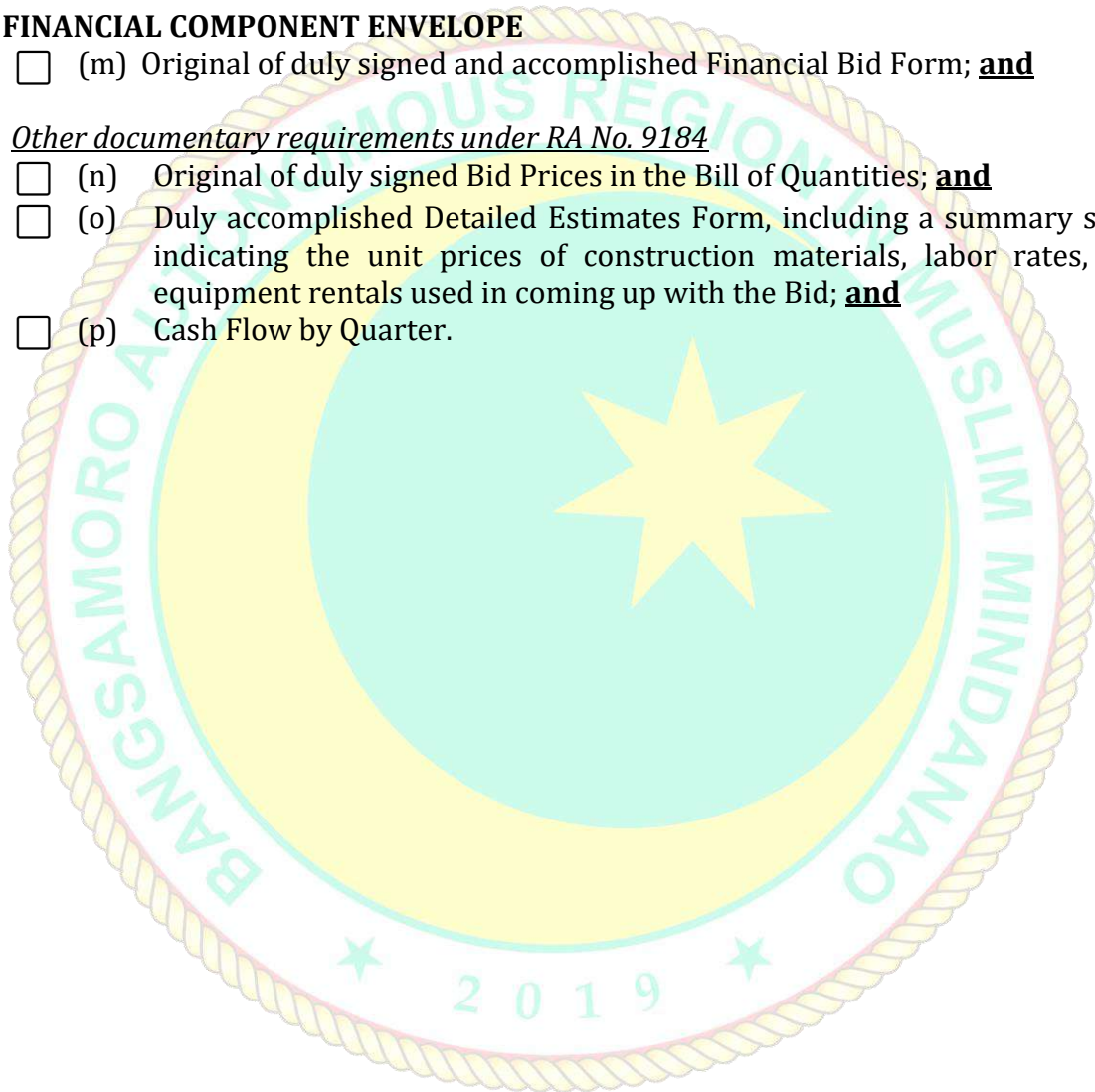

## Section X. Bidding Forms



## Bid Form for the Procurement of Infrastructure Projects

*[shall be submitted with the Bid]*

### BID FORM

Date : \_\_\_\_\_

Project Identification No. : \_\_\_\_\_

To: **OFFICE OF THE CHIEF MINISTER**  
Bangsamoro Government Center, Cotabato City

Having examined the Philippine Bidding Documents (PBDs) including the Supplemental or Bid Bulletin Numbers *[insert numbers]*, the receipt of which is hereby duly acknowledged, we, the undersigned, declare that:

- a. We have no reservation to the PBDs, including the Supplemental or Bid Bulletins, for the Procurement Project: *[insert name of contract]*;
- b. We offer to execute the Works for this Contract in accordance with the PBDs;
- c. The total price of our Bid in words and figures, excluding any discounts offered below is: *[insert information]*;
- d. The discounts offered and the methodology for their application are: *[insert information]*;
- e. The total bid price includes the cost of all taxes, such as, but not limited to: *[specify the applicable taxes, e.g. (i) value added tax (VAT), (ii) income tax, (iii) local taxes, and (iv) other fiscal levies and duties]*, which are itemized herein and reflected in the detailed estimates,
- f. Our Bid shall be valid within the/a period stated in the PBDs, and it shall remain binding upon us at any time before the expiration of that period;
- g. If our Bid is accepted, we commit to obtain a Performance Security in the amount of *[insert percentage amount]* percent of the Contract Price for the due performance of the Contract, or a Performance Securing Declaration in lieu of the the allowable forms of Performance Security, subject to the terms and conditions of issued GPPB guidelines<sup>2</sup> for this purpose;

---

<sup>2</sup> currently based on GPPB Resolution No. 09-2020



- h. We are not participating, as Bidders, in more than one Bid in this bidding process, other than alternative offers in accordance with the Bidding Documents;
- i. We understand that this Bid, together with your written acceptance thereof included in your notification of award, shall constitute a binding contract between us, until a formal Contract is prepared and executed; and
- j. We understand that you are not bound to accept the Lowest Calculated Bid or any other Bid that you may receive.
- k. We likewise certify/confirm that the undersigned, is the duly authorized representative of the bidder, and granted full power and authority to do, execute and perform any and all acts necessary to participate, submit the bid, and to sign and execute the ensuing contract for the [Name of Project] of the [Name of the Procuring Entity].
- l. We acknowledge that failure to sign each and every page of this Bid Form, including the Bill of Quantities, shall be a ground for the rejection of our bid.

Name: \_\_\_\_\_

Legal Capacity: \_\_\_\_\_

Signature: \_\_\_\_\_

Duly authorized to sign the Bid for and behalf of: \_\_\_\_\_

Date: \_\_\_\_\_

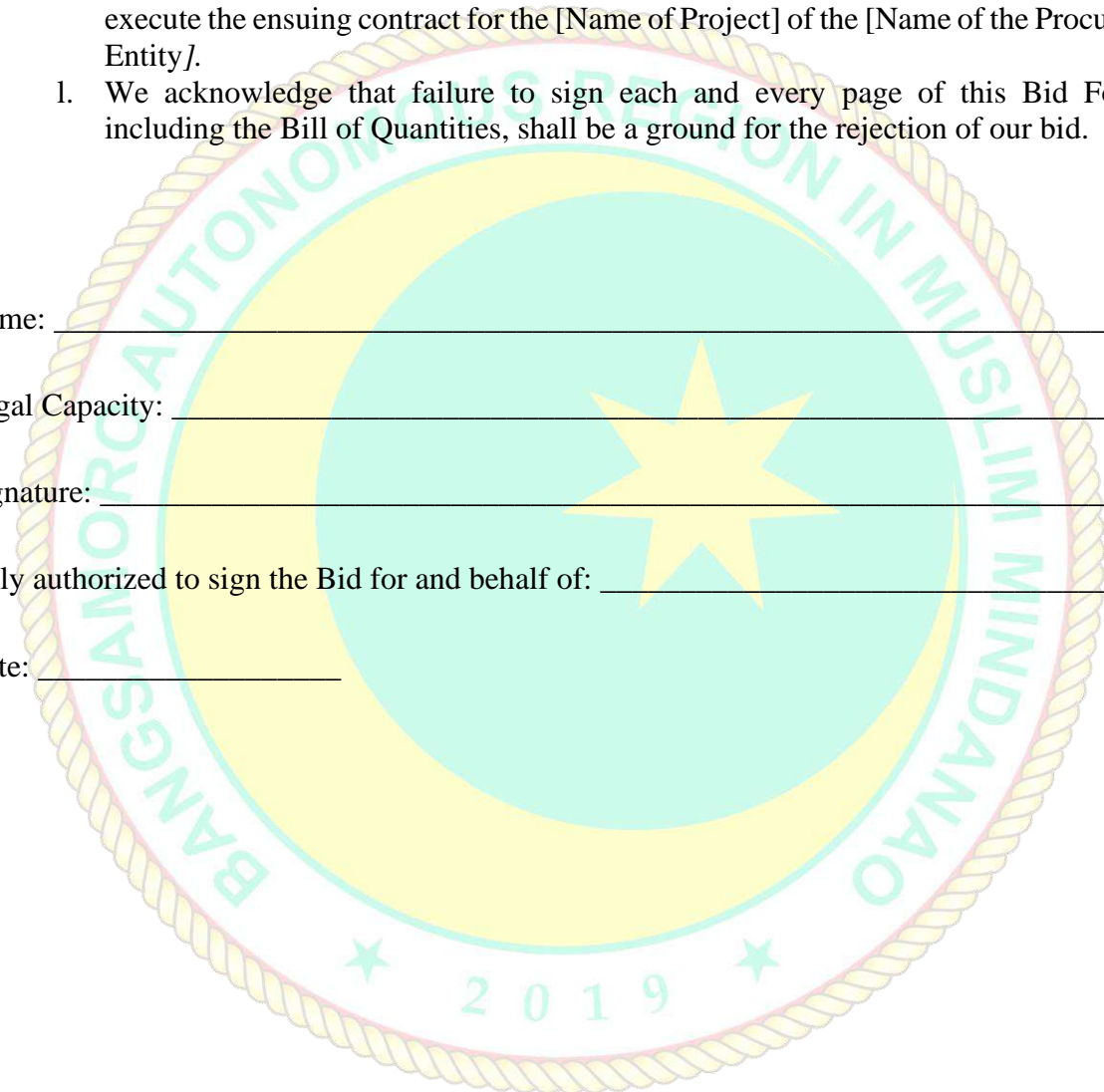

## Bid Securing Declaration Form

*[shall be submitted with the Bid if bidder opts to provide this form of bid security]*

---

REPUBLIC OF THE PHILIPPINES)  
CITY OF \_\_\_\_\_) S.S.

### BID SECURING DECLARATION Project Identification No.: *[Insert number]*

To: *Office of the Chief Minister  
Bangsamoro Government Center, Cotabato City*

I/We, the undersigned, declare that:

1. I/We understand that, according to your conditions, bids must be supported by a Bid Security, which may be in the form of a Bid Securing Declaration.
2. I/We accept that: (a) I/we will be automatically disqualified from bidding for any procurement contract with any procuring entity for a period of two (2) years upon receipt of your Blacklisting Order; and, (b) I/we will pay the applicable fine provided under Section 6 of the Guidelines on the Use of Bid Securing Declaration, within fifteen (15) days from receipt of the written demand by the procuring entity for the commission of acts resulting to the enforcement of the bid securing declaration under Sections 23.1(b), 34.2, 40.1 and 69.1, except 69.1(f), of the IRR of RA No. 9184; without prejudice to other legal action the government may undertake.
3. I/We understand that this Bid Securing Declaration shall cease to be valid on the following circumstances:
  - a. Upon expiration of the bid validity period, or any extension thereof pursuant to your request;
  - b. I am/we are declared ineligible or post-disqualified upon receipt of your notice to such effect, and (i) I/we failed to timely file a request for reconsideration or (ii) I/we filed a waiver to avail of said right; and
  - c. I am/we are declared the bidder with the Lowest Calculated Responsive Bid, and I/we have furnished the performance security and signed the Contract.

IN WITNESS WHEREOF, I/We have hereunto set my/our hand/s this \_\_\_\_ day of *[month]* *[year]* at *[place of execution]*.

*[Insert NAME OF BIDDER OR ITS AUTHORIZED  
REPRESENTATIVE]*

*[Insert signatory's legal capacity]*  
Affiant

**SUBSCRIBED AND SWORN** to before me this \_\_\_\_ day of *[month]* *[year]* at *[place of execution]*, Philippines. Affiant/s is/are personally known to me and was/were identified by me through competent evidence of identity as defined in the 2004 Rules on Notarial Practice (A.M. No. 02-8-13-SC). Affiant/s exhibited to me his/her *[insert type of government identification card used]*, with his/her photograph and signature appearing thereon, with no. \_\_\_\_\_ and his/her Community Tax Certificate No. \_\_\_\_\_ issued on \_\_\_\_ at \_\_\_\_\_.



Witness my hand and seal this \_\_\_\_ day of [month] [year].

NAME OF NOTARY PUBLIC

Serial No. of Commission \_\_\_\_\_

Notary Public for \_\_\_\_\_ until \_\_\_\_\_

Roll of Attorneys No. \_\_\_\_\_

PTR No. \_\_\_\_\_ [date issued], [place issued]

IBP No. \_\_\_\_\_ [date issued], [place issued]

Doc. No. \_\_\_\_\_

Page No. \_\_\_\_\_

Book No. \_\_\_\_\_

Series of \_\_\_\_\_



**Omnibus Sworn Statement (Revised)**  
*[shall be submitted with the Bid]*

---

REPUBLIC OF THE PHILIPPINES )  
CITY/MUNICIPALITY OF \_\_\_\_\_ ) S.S.

**AFFIDAVIT**

I, **[Name of Affiant]**, of legal age, **[Civil Status]**, **[Nationality]**, and residing at **[Address of Affiant]**, after having been duly sworn in accordance with law, do hereby depose and state that:

1. *[Select one, delete the other:]*  
*[If a sole proprietorship:]* I am the sole proprietor or authorized representative of **[Name of Bidder]** with office address at **[address of Bidder]**;  
*[If a partnership, corporation, cooperative, or joint venture:]* I am the duly authorized and designated representative of **[Name of Bidder]** with office address at [address of Bidder];
2. *[Select one, delete the other:]*  
*[If a sole proprietorship:]* As the owner and sole proprietor, or authorized representative of **[Name of Bidder]**, I have full power and authority to do, execute and perform any and all acts necessary to participate, submit the bid, and to sign and execute the ensuing contract for **[Name of the Project]** of the Office of the Chief Minister, as shown in the attached duly notarized Special Power of Attorney;  
*[If a partnership, corporation, cooperative, or joint venture:]* I am granted full power and authority to do, execute and perform any and all acts necessary to participate, submit the bid, and to sign and execute the ensuing contract for **[Name of the Project]** of the Office of the Chief Minister, as shown in the attached **[state title of attached document showing proof of authorization (e.g., duly notarized Secretary's Certificate, Board/Partnership Resolution, or Special Power of Attorney, whichever is applicable);]**;
3. **[Name of Bidder]** is not "blacklisted" or barred from bidding by the Government of the Philippines or any of its agencies, offices, corporations, or Local Government Units, foreign government/foreign or international financing institution whose blacklisting rules have been recognized by the Government Procurement Policy Board, by itself or by relation, membership, association, affiliation, or controlling interest with another blacklisted person or entity as defined and provided for in the Uniform Guidelines on Blacklisting;
4. Each of the documents submitted in satisfaction of the bidding requirements is an authentic copy of the original, complete, and all statements and information provided therein are true and correct;
5. **[Name of Bidder]** is authorizing the Head of the Procuring Entity or its duly authorized representative(s) to verify all the documents submitted;
6. *[Select one, delete the rest:]*  
*[If a sole proprietorship:]* The owner or sole proprietor is not related to the Head of the Procuring Entity, members of the Bids and Awards Committee (BAC), the Technical Working Group, and the BAC Secretariat, the head of the Project Management Office or

the end-user unit, and the project consultants by consanguinity or affinity up to the third civil degree;

*[If a partnership or cooperative:]* None of the officers and members of *[Name of Bidder]* is related to the Head of the Procuring Entity, members of the Bids and Awards Committee (BAC), the Technical Working Group, and the BAC Secretariat, the head of the Project Management Office or the end-user unit, and the project consultants by consanguinity or affinity up to the third civil degree;

*[If a corporation or joint venture:]* None of the officers, directors, and controlling stockholders of *[Name of Bidder]* is related to the Head of the Procuring Entity, members of the Bids and Awards Committee (BAC), the Technical Working Group, and the BAC Secretariat, the head of the Project Management Office or the end-user unit, and the project consultants by consanguinity or affinity up to the third civil degree;

7. *[Name of Bidder]* complies with existing labor laws and standards; and
8. *[Name of Bidder]* is aware of and has undertaken the responsibilities as a Bidder in compliance with the Philippine Bidding Documents, which includes:
  - a. Carefully examining all of the Bidding Documents;
  - b. Acknowledging all conditions, local or otherwise, affecting the implementation of the Contract;
  - c. Making an estimate of the facilities available and needed for the contract to be bid, if any; and
  - d. Inquiring or securing Supplemental/Bid Bulletin(s) issued for the *[Name of the Project]*.
9. *[Name of Bidder]* did not give or pay directly or indirectly, any commission, amount, fee, or any form of consideration, pecuniary or otherwise, to any person or official, personnel or representative of the government in relation to any procurement project or activity.
10. In case advance payment was made or given, failure to perform or deliver any of the obligations and undertakings in the contract shall be sufficient grounds to constitute criminal liability for Swindling (Estafa) or the commission of fraud with unfaithfulness or abuse of confidence through misappropriating or converting any payment received by a person or entity under an obligation involving the duty to deliver certain goods or services, to the prejudice of the public and the government of the Philippines pursuant to Article 315 of Act No. 3815 s. 1930, as amended, or the Revised Penal Code.

**IN WITNESS WHEREOF**, I have hereunto set my hand this \_\_\_ day of \_\_\_, 20\_\_ at \_\_\_\_\_, Philippines.

***[Insert NAME OF BIDDER OR ITS  
AUTHORIZED REPRESENTATIVE]***

***[Insert signatory's legal capacity]***

**Affiant**

**SUBSCRIBED AND SWORN** to before me this \_\_\_ day of [month] [year] at [place of execution], Philippines. Affiant/s is/are personally known to me and was/were identified by me through competent evidence of identity as defined in the 2004 Rules on Notarial Practice (A.M. No. 02-8-13-SC). Affiant/s exhibited to me his/her [insert type of government

identification card used], with his/her photograph and signature appearing thereon, with no. \_\_\_\_\_ and his/her Community Tax Certificate No. \_\_\_\_\_ issued on \_\_\_\_ at \_\_\_\_\_.

Witness my hand and seal this \_\_\_\_ day of [month] [year].

NAME OF NOTARY PUBLIC

Serial No. of Commission \_\_\_\_\_

Notary Public for \_\_\_\_\_ until \_\_\_\_\_

Roll of Attorneys No. \_\_\_\_\_

PTR No. \_\_\_\_\_ [date issued], [place issued]

IBP No. \_\_\_\_\_ [date issued], [place issued]

Doc. No. \_\_\_\_\_

Page No. \_\_\_\_\_

Book No. \_\_\_\_\_

Series of \_\_\_\_\_

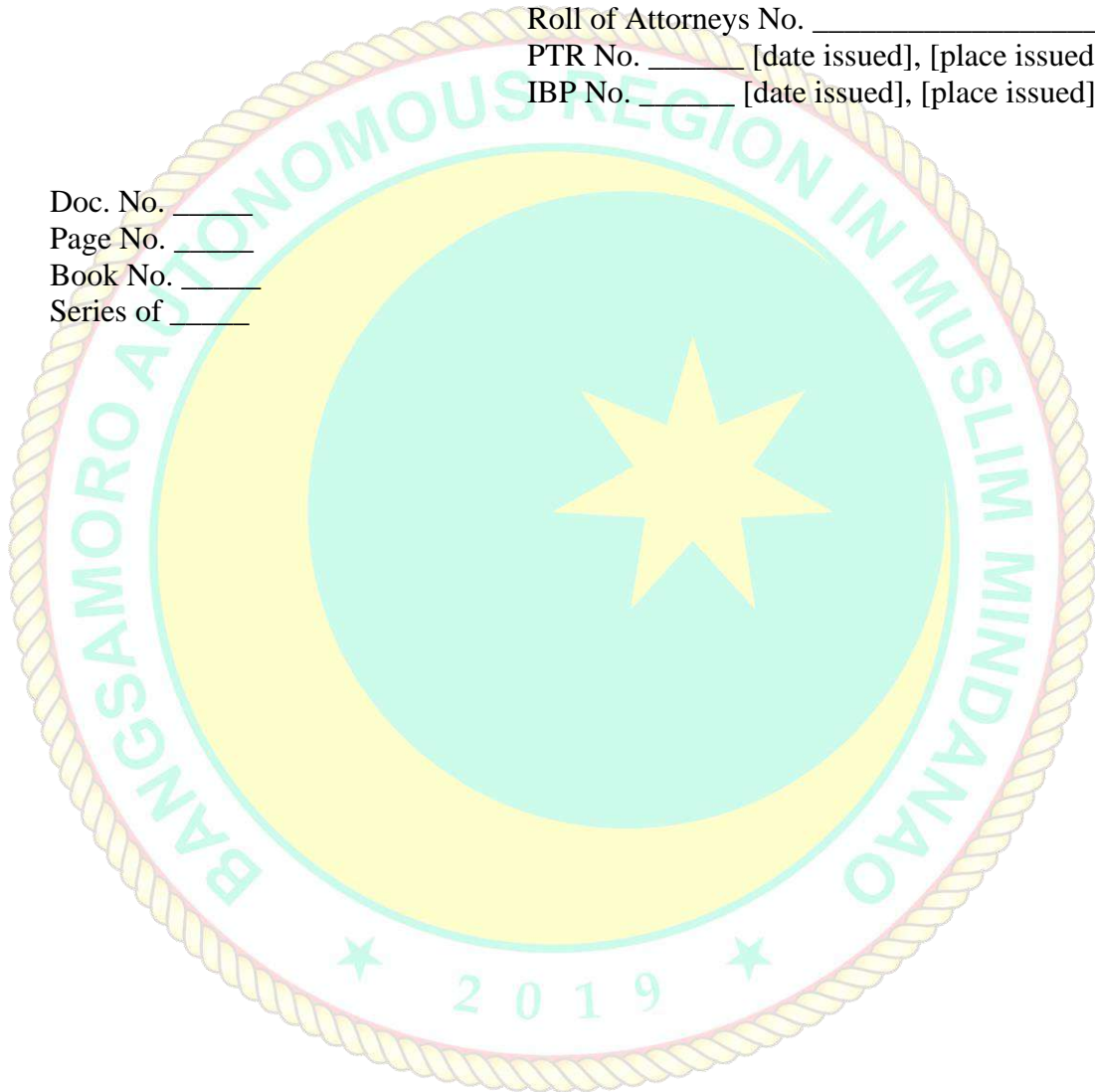

**STATEMENT OF SINGLE LARGEST COMPLETED CONTRACT SIMILAR TO  
THE CONTRACT TO BE BID**





**NAME OF THE BIDDER OR ITS AUTHORIZED REPRESENTATIVE AND ITS SIGNATURE**  
Designation







**STATEMENT OF ALL ONGOING GOVERNMENT AND PRIVATE CONTRACTS**

Name of the Company: \_\_\_\_\_

Address: \_\_\_\_\_

**STATEMENT OF ALL ONGOING GOVERNMENT AND PRIVATE CONTRACTS, INCLUDING AWARDED BUT NOT YET STARTED**

Name of Contract	a. Name of the Procuring Entity; b. Contact Person; c. Address; d. Contact Nos:	a. Contract References (PO/Contract); b. Contract Date c. Contract Duration	a. Estimated Completion or Delivery	Contract Amount	% of Accomplishment		Value of Outstanding Works/Undelivered Portion
					Planned	Actual	
<b>GOVERNMENT</b>							
<b>PRIVATE</b>							
					<b>Total Cost</b>		

This statement shall be supported by:

1. Notice of Award;
2. Contract, if applicable; and
3. Notice to Proceed, if applicable.

Submitted by:

**NAME OF THE BIDDER OR ITS AUTHORIZED REPRESENTATIVE AND ITS SIGNATURE**

Designation





Republic of the Philippines



Government Procurement Policy Board